

# FOREWORD OF ANATOLII ZAGORODNII, PRESIDENT OF THE NATIONAL ACADEMY OF SCIENCES OF UKRAINE

Dear colleagues!

In spite of the extremely difficult circumstances of the wartime, the National Academy of Sciences of Ukraine not only has largely retained its viability and research potential but it has adapted to new realities and continues to play an important role in strengthening the defense, security and development of this country.

After the beginning of Russia's large-scale military invasion, the Academy rethought the priorities of its activities. Without abandoning its basic-research projects and depriving them of the necessary support, today we are focusing our main efforts on developing innovative technologies for the defense sector and providing scientific foundation for solving the most pressing problems of the state.

Institutes of the NAS of Ukraine continue basic research in the key areas of science — physics, astronomy, informatics, molecular biology, chemistry. In the context of modern challenges — energy crisis, the need for economic recovery and fast reconstruction of the country in particular, Academy scientists focused on practice-oriented developments and implementation of innovations. Especially, on elaborating the strategies for energy security and restoration of critical infrastructure, economic revival of Ukraine and support to its key industries, advancement of digital technologies, increasing the efficiency of the agro-industrial complex, searching for novel methods of water, soil and air decontamination, on medical innovations and biotechnologies, etc. Of great importance are works of scholars in socio-humanities, who study current military and political realities and their influence on Ukrainian society. Our scholars are actively counteracting the "Russian world" ideology and Russian historical propaganda through their profound studies, publications and educational activities.

In 2024, Academy's international cooperation became significantly broader and deeper. It makes significant efforts towards involving the aid of international partners for retaining and restoring its scientific infrastructure, providing support to Ukrainian researchers. In particular, the results of international meetings in

Poland, Germany, Turkey were very useful. A series of our colleagues' visits to the NAS of Ukraine and its institutions took place as well.

Numerous programs in support of Ukrainian scientists and scholars which were launched by the governments, science centers, academies of many countries after the beginning of the Russian armed aggression are continued. New contests were also announced. Besides, active participation of Academy's research teams in international programs never stops. Scientific cooperation in the framework of 47 projects of the EU Framework Programme for Research and Innovation "Horizon Europe" and the Research and Education Programme of the European Nuclear Energy Community was successful. The implementation of 14 multi-year projects under NATO Programme "Science for Peace and Security" was going on.

We continue to work hard on improving Academy's activities. The reforms are aimed at increasing its work efficiency, integrating Ukrainian science to global research area, ensuring transparent financing, and involving young scientists. In terms of research topics, we continue to keep track of the novel areas of global science development. In particular, we build up our efforts towards strengthening research in such highly relevant fields as artificial intelligence, quantum computations, quantum technologies and quantum materials. To this end, coordination councils for those areas were set up and advanced their activities. The assessment of Academy institutions according to a specially developed procedure is going on. The results of this assessment are used to optimize the allocation of budgetary finance, improve the network of scientific institutions and their structures. The work for optimization of the network of enterprises and organizations within the Academy, inventory of their material and technical base as well as land plots is continued. We are constantly strengthening communication with the society and power structures.

We continue to work for the good of the people of Ukraine, realizing our responsibility to society. Science remains our instrument in the struggle for strong, independent and technologically advanced Ukraine, and despite all difficulties we do not stop, because we know: our knowledge, experience and hard work today are the guarantee of safe and successful future of the nation.

And we do realize that our activities are only possible due to the boundless courage and self-sacrifice of our soldiers who defend Ukraine at the front. At the same time, scholars of the NAS of Ukraine demonstrate exceptional resilience, continuing research in extremely difficult conditions — amid blackouts, missile attacks and with limited resources. Notwithstanding all difficulties they mobilized their knowledge and experience to support the country at the time of war.

This joint contribution — that of the military at the frontline and of scientists in the rear is the guarantee of our Victory. I am sure that owing to the heroism of the military and the tireless work of the scientific community, Ukraine will both withstand in the war and lay the foundation of its future development and revival.

With faith in Victory!  
Anatolii ZAGORODNII

# IMPORTANT EVENTS

**In accordance with the Statute of the National Academy of Sciences of Ukraine, on 22—25 April 2024, sessions of the General Meeting of the NAS of Ukraine and the general meetings of its departments were held. They considered the prospects of advancing research and developments in respective areas and held elections of NAS members.**

On 24 April 2024, in Kyiv, a session of the NAS General Meeting was held, which considered the results of Academy's work in 2023 and its tasks for the next period. Opening the event, its President NAS academician Anatolii Zagorodnii stressed: "The Academy, together with the whole Ukraine, lived another difficult year of the struggle against the large-scale Russian aggression. During martial law, the Academy was able to mobilize resources, adapt to hard conditions of life and work, find a lot of new opportunities". He noted that last year Academy scientists continued both basic research in priority fields of world science and applied studies and developments for enhancing the defense potential and security of the state, restoring its damaged national economy. "All the time the war poses new challenges and supertasks for our nation — to win and rebuild. The Academy should get actively involved in elaborating the plans of such restoration and, surely, in implementing them", the Academy leader stressed.

After that, NAS Academician Anatolii Zagorodnii made a report on the main results of the activities of the NAS of Ukraine in 2023 and on future tasks.

The report presented the main research results, which in spite of all difficulties and challenges were obtained by Academy scholars in the reporting period. They, in particular, were aimed at strengthening the defense potential and security of the country, dealing with numerous other issues that are highly relevant for the state and society.

The President of the NAS of Ukraine spoke about the collaboration with ministries and departments, with national branch academies of sciences and higher education institutions, international cooperation, scientific expertise activities of the Academy, measures in support of young scientists. In the report he outlined problems in NAS activities: insufficient funding, the necessity of preserving human resource potential, restoring the damaged research infrastructure, optimizing the structure of the Academy.

Academician Anatolii Zagorodnii also outlined the main tasks for the future.

After the report of the NAS President Anatolii Zagorodnii, Denys Kurbatov — the deputy Minister of Education and Science of Ukraine — announced greetings of Ukraine's Prime Minister Denys Shmyhal to the participants of the NAS General Meeting.

Scholars of the National Academy of Sciences of Ukraine and of the national branch academies of Ukraine, heads of industrial enterprises, of central executive bodies and the National Council for the Development of Science and Technologies of Ukraine took part in discussing the report.

After the discussion of the report was completed the General Meeting of the NAS of Ukraine approved the Report on the NAS activities in 2023 by adopting a relevant resolution.

The annual awarding of V.I. Vernadsky Gold Medal — the highest honor of the National Academy of Sciences of Ukraine — has become a good tradition. According to the results of the 2023 competition, these medals were awarded to NAS academician Serhiy Komisarenko for outstanding achievements in molecular immunology and to professor Aaron Ciechanover, foreign member of the Academy, for prominent accomplishments in protein biochemistry.

After that, the NAS Prize "For Popularizing Science" (in accordance with the 2023 results) was solemnly presented. This prize is awarded to mass media and their representatives, scholars and independent project organizers for the best press release on scientists' achievements, activities of research institutions and the NAS in general, as well as for promoting science popularization and raising the prestige of the scientific profession in Ukraine.

Then NAS President Anatolii Zagorodnii handed diplomas to the laureates of prizes named after outstanding scientists of Ukraine according to the results of 2023 contest.

Summing up the session, the Academy President noted that even in the difficult wartime conditions the Academy worked fruitfully, producing scientific results of high quality. Along with that he emphasized that many problems persist in its life, which should be dealt with timely and effectively. "Despite the hardships, we should maintain a high level of basic and applied research, and most importantly, preserve research teams and human resource potential, since people are the main value of the Academy. The urgent task is to restore and develop scientific infrastructure. Besides, the war is going on, therefore, scientists must actively and significantly contribute to ensuring the defense and security of Ukraine, and, at the same time, to actively make plans for the post-war reconstruction, recovering the economy and social sphere" the Academy leader stressed.

On 25 April 2024, the session of the NAS General Meeting elected active members (academicians) and corresponding members of the NAS of Ukraine.

For the election in question, the Academy Presidium announced 28 vacancies of academicians and 75 vacancies of corresponding members in 66 specializations.

The basis for vacancies distribution across departments and specialization designation was the striving to provide priority development of basic science, first and foremost, in the areas where Ukrainian scientists have world-class results. An important task was to represent different regions of Ukraine, both academy and non-academy institutions, to improve gender balance of Academy members. During the preparation of proposals for opening the vacancies of academicians and corresponding members, special attention was given to significant rejuvenation of Academy membership. For this purpose, an age limit was set for some vacancies (that including the last day of application): under 65 years old for active members and under 55 for corresponding members. Besides, in the case of introducing a vacancy with the limit age of the candidates, the simultaneous introduction of the same vacancy without the age limit was ensured.

The entire preparation to the election was held openly and with freedom of discussing the candidates. At the decisive stage of the election campaign — general meetings of the departments — all conditions for free exchange of opinions, critical speeches, proposals were provided as well, which undoubtedly facilitated an informed, objective and independent choice.

74 candidates for the vacancies of academicians and 246 for those of corresponding members were nominated and registered. 28 NAS academicians and 74 corresponding members of the NAS of Ukraine were elected by secret ballot. 23 (23%) of those represented higher education institutions and other organizations, 19% of them were representatives of higher education, and 4% were scholars working at other institutions and organizations of Ukraine.

The introduction of target vacancies with the limit age under 65 years for academicians and 55 years for corresponding members allowed the average age of Academy members to be reduced significantly: as compared to the previous election to the NAS of Ukraine, the average age of academicians decreased by four years, and that of corresponding members — by seven years.

**On 11 September 2024, in Kyiv, in the Large Conference Hall of the NAS of Ukraine, a Jubilee Session of the NAS General Meeting honoring the 100-year anniversary of Platon G. Kostyuk was held.** The ceremonial gathering was attended by NAS members, scientists of Academy institutions, and university students.

NAS academician Anatolii Zagorodnii opened the ceremonial General Meeting of the NAS of Ukraine. "No doubt, this meeting is a landmark event for the whole scientific community, since Platon Kostyuk was an outstanding personality, world-famous scientist whose



*Session of the General Meeting of the NAS of Ukraine, 24 April 2024*

contribution to the development of neurophysiology and medicine is difficult to be overestimated. A clear proof of it is that he was elected a member of both domestic and numerous international and foreign academies and scientific societies", he noted in the welcome speech and stressed that scientific achievements of Platon G. Kostyuk became the basis for the emergence of new and the development of established scientific areas, in particular, those in physiology and neuro sciences, they opened up new horizons for studying and implementing innovative methods in practical medicine. He discovered the phenomenon of selective conductivity of the soma of nerve cells. Besides, his attention was focused on studying the cellular mechanisms of brain activity and establishing the principles of information transfer in the nervous system.

Anatolii Zagorodnii emphasized that academician Platon Kostyuk was, without exaggeration, a prominent personality, scientist and public figure who played an important role in the formation of Ukrainian statehood. As the Head of the Verkhovna Rada (Parliament) of Ukraine he made much effort for elaborating Ukraine's legislative framework, and for developing its science and education.

Veleryi Koliukh, member of Verkhovna Rada Committee on education, science and innovations, Chairman of the subcommittee for higher education, People's Deputy of Ukraine, delivered a greeting to the participants of the NAS General Meeting on behalf of the Chairman of the Verkhovna Rada of Ukraine Ruslan Stefanчук.

Then NAS academicians Mykola Veselovskyi, Serhiy Komisarenko, Oleh Krishtal, Yaroslav Shuba shared their memories of the life and creative work of academician Platon G. Kostyuk. Besides, his daughter, candidate of medical science Olga P. Kostyuk, gave interesting details of the family life of the outstanding scientist and public figure.

**On 30 October 2024, a meeting of NAS Presidium reviewed the results of implementing the Targeted Defense R&D Program of the NAS of Ukraine for**

**2020—2024.** Its head, the First Vice-President of the NAS of Ukraine, NAS academician Volodymyr Gorbulin pointed out that during its implementation NAS institutions obtained significant R&D and practical results which promoted the execution of certain tasks of developing technologies in the sphere of manufacturing weapons and military equipment.

In 2020—2024, under this program 122 research projects were fulfilled, involving 36 Academy institutions. These works were aimed at the development of software and multi-sensor systems, in particular those with artificial intelligence elements, innovative or import-substituting technologies, new types of substances, materials and coatings with specified physico-mechanical, physico-chemical or medico-biological properties.

The fundamental feature of this program is that priority tasks for its annual contests are determined by the General Staff of the Armed Forces of Ukraine, the Ministry of Defense of Ukraine, the Central R&D Institute of Armaments and Military Technology of Ukraine, and the 'Ukrainian Defense Industry' joint-stock company. The same organizations carry out external examination of the requests submitted to the contest and also take part in the commissions accepting the completed works. The Central Research Institute of Armaments and Military Equipment of the Armed Forces of Ukraine accompanies those works, in particular, agrees their technical specifications determined by potential consumers of the results — enterprises of military-industrial complex.

Representatives of the abovementioned departments, institutions and organizations of the defense sector who spoke during summarizing the program stressed the importance of the results produced by Academy institutions for enhancing the defense capability and security of the state, their special importance during martial law.

Due to the relevance, importance and prospects of the results produced under the program, it was considered necessary to start the implementation of another targeted S&T program of defense research at the NAS of Ukraine for 2025—2029.

**On 27 November 2024, an enlarged meeting of the NAS Presidium chaired by the NAS President Anatolii Zagorodnii was held. It discussed further improvement of Academy activities under martial law.** The meeting was opened by the NAS President Anatolii Zagorodnii, who addressed its participants with an opening speech. He stressed that current realities require from the Academy maximum adaptability, practicality and orientation towards solving urgent tasks of the state. The war makes scientists significantly re-orient their research for solving important applied problems in the interests of increasing defense capability and security, mobilize resources and use all possibilities for supporting the country in the war time and during post-war

recovery. The Academy leader presented the results of implementing the Targeted R&D Program of Defense Research, a part of which had already been fulfilled, the rest being at the stage of introduction and testing. He stressed that from the next year a 1.7-time increase in defense industry funding would be provided.

At the same time, important tasks for the near future should be R&D aimed at economic progress of the country, which would be based on advanced technologies both in the wartime and in the post-war period, along with advanced research areas, namely, the development of microelectronics, artificial intelligence, quantum materials and quantum technologies, integration to the European open-science cloud.

Of utmost necessity is combining efforts of different institutes around important applied-science issues, in particular, their participation in forming innovation clusters in certain high-tech production areas for involving investment to science, cooperation of research institutions with business and industry, joint production of new knowledge and technologies.

Academician Anatolii Zagorodnii spoke about the 2025 funding of the Academy and stressed that even additional finance does not generate great optimism as to significant improvement of the financial situation. Therefore, our task is to involve as much extrabudgetary revenues as possible. First of all, that should be done through the assistance of foreign partners and the participation of Academy scientists in research projects and competitions.

The President of the Academy stressed the importance of continuing the implementation of the plan of reforming the Academy, of further improvements in the approaches to distributing the basic funding across the NAS institutions and the procedures of assessing research institutions of the NAS of Ukraine, strengthening the measures in support of young scientists and those towards popularizing science.

After that, NAS academicians Valeriy Heyets, Serhii Firstov, Olexandr Tymokha, NAS corresponding members Serhii Maksimov, Alla Buyskikh, Doctor of Science in History Oleksandr Udod, Doctor of Science in Public Administration Valeriya Kovach, Candidate of Science in Chemistry Oleksandr Zolotarenko reported on their achievements and problems, presented concrete proposals concerning the improvement of the NAS activities.

According to the results of the meeting, a resolution of the NAS Presidium was approved, which provided for a number of measures for further improvement of Academy's activities during martial law, in particular, those towards reforming its activities, preserving its scientific, S&T potential, scientific support to dealing with issues of socio-economic development of the country, raising its defense capability.

# SCIENTIFIC ACHIEVEMENTS. NATURAL AND ENGINEERING SCIENCES

## Detection of the effect of absorbing galactic low-frequency radio emission in interstellar plasma

For over half a century Ukraine has been the leader in the field of long-wave radio astronomy — observations of radio emission at frequencies lower than 30 MHz. That became possible due to creating and using the world-largest radio telescopes UTR-2, URAN, GURT, which are recognized as the National Scientific Asset. Despite the rapid progress in low-frequency radio astronomy, Ukrainian radio telescopes remain the most effective and requested equipment for studying the Universe at the longest wavelengths, which can be used from the Earth's surface.

Researchers of the NAS Institute of Radio Astronomy, during processing of the unique observational database obtained by means of UTR-2 radio telescope, detected an unusual effect of absorbing non-thermal radio emission from the Milky Way in its continuous spectrum. This priority result was obtained due to deep upgrading of observation means and techniques, in

particular broadening of the frequency band, optimal combination of time, frequency and space resolutions at observation stages, along with data processing with the use of innovative, digital, telecommunication, and information technologies. As a result, a record sensitivity, noise immunity and efficiency of measuring the parameters of various types of cosmic radio signals were achieved and greater opportunities of detecting new astronomical objects and phenomena appeared.

It was established that the discovered effects are due to absorption in partially ionized cold rarefied interstellar plasma at temperatures below 100 K and the density below  $1 \text{ cm}^{-3}$ , which occupies the lion's share of the Galaxy's volume but earlier had been inaccessible for studying. This medium plays the primary role in the energetics, dynamics and evolution of the interstellar matter, including the processes of star formation. Moreover, it is in such plasma that spectral recombination radio lines of record-highly excited carbon and hydrogen atoms can emerge, which had also been discovered with UTR-2 and detected in absorption for the first time. Therefore, Ukrainian radio astronomy discovered a new class of objects of galactic origin — "negative polarization" bodies. They can be observed in continuous radio emission, in spectral lines and in sporadic radio bursts. This opens up new possibilities of determining temperature, density, pressure, velocity, the mechanisms of heating, cooling, ionization and recombination in gas and dust complexes of the Galaxy, i.e. new methods for comprehensive diagnostics of interstellar plasma are gradually being formed.

*O. Konovalenko, Y. Vasylykivskyi, S. Stepkin, V. Zakharenko, O. Ulyanov*

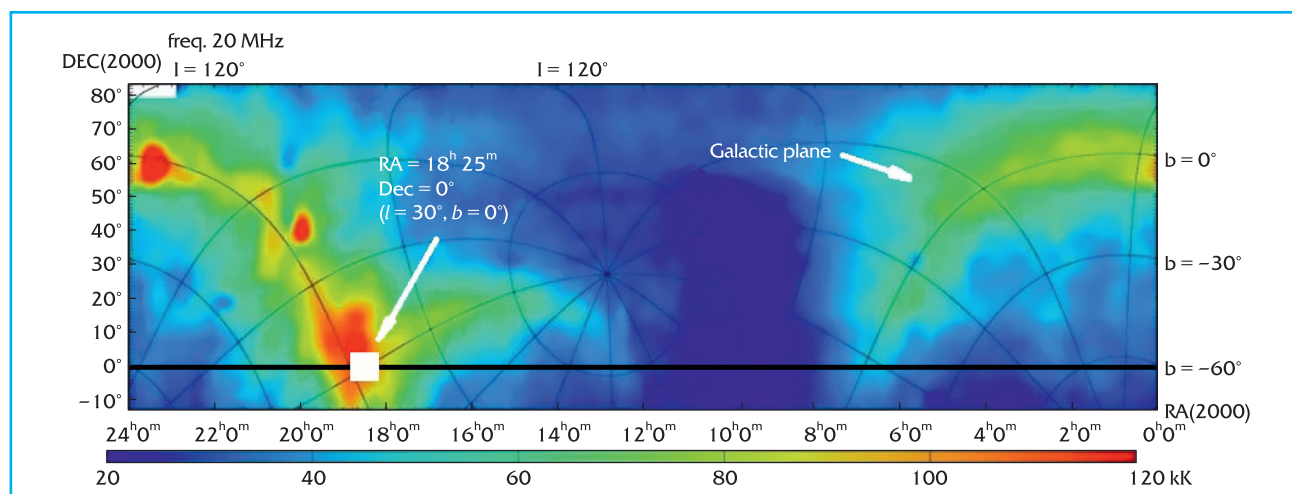

Distribution map of Galaxy non-thermal radio emission, which was built with the use of UTR-2 at the frequency of 20 MHz. The horizontal line shows the Galaxy intersection during sky scanning by UTR-2 beam during diurnal Earth rotation for declination  $\text{Dec} = 0^\circ$ . A white square shows the zone where the absorption effect was detected

### **<sup>6</sup>Li and <sup>7</sup>Li nuclear synthesis reactions and cosmological lithium problem**

In the first moments after the Big Bang, nuclei of light elements emerged, which is called the primordial nucleosynthesis. Most predictions coincide with observations but there is a problem with <sup>7</sup>Li: there must be 3—4 times more of it than the old stars actually contain.

According to current ideas, the main source of <sup>7</sup>Li is beryllium <sup>7</sup>Be, which transforms into <sup>7</sup>Li due to electron capture. The reactions that destroy <sup>7</sup>Be can reduce the amount of lithium as well. To understand these processes, nuclear reactions were investigated at low temperatures — in the range where nuclear transformations occurred at the beginning of the Universe. Deuteron collisions with <sup>7</sup>Be and <sup>7</sup>Li nuclei were studied experimentally, and researchers of Bogolyubov Institute for Theoretical Physics of the NAS of Ukraine carried out the micro description of such reactions. It helped agree the theory with the experiment and better understand the role of the above processes in the formation of light elements.

Instead of the usual cross-sections of nuclear reactions, a method relying on astrophysical S-factors

was proposed. They take into account the Coulomb barrier in the collisions of particles of the same charge and simplify the comparison of the theory and the experiment. Besides, they enable the prediction of the behavior of these reactions in the energy range characteristic of the first minutes of the Universe existence, when the primordial nucleosynthesis of light nuclei occurred.

The same approaches were used for the analysis of <sup>6</sup>Li reactions with tritium <sup>3</sup>H or helium <sup>3</sup>He. In these cases, experimental data are lacking but theoretical predictions coincide with the available results. It turned out that S-factors of <sup>6</sup>Li with <sup>3</sup>H and <sup>3</sup>He differ significantly due to Coulomb interaction and differences in the energies of the quantum states of beryllium <sup>9</sup>Be and boron <sup>9</sup>B compound nuclei. However, since reliable experimental data are still lacking, further computations are necessary. In fact, they are the only guideline for future research that should be aimed at a more accurate determination of <sup>6</sup>Li and <sup>7</sup>Li nuclei distribution in the early Universe, which is to bring closer the solution of the cosmological lithium problem.

*V. Vasylevskyi, Yu. Lashko, V. Zhaba*

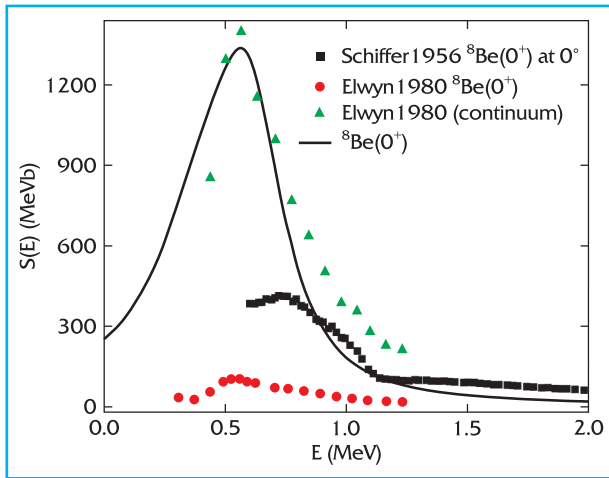

Calculated and obtained from experimental data S-factors of <sup>6</sup>Li + <sup>3</sup>He → <sup>8</sup>Be + p reaction

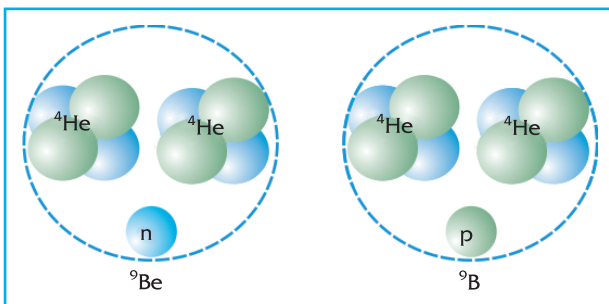

Structure of <sup>9</sup>B and <sup>9</sup>Be compound nuclei formed at the intermediate stage of <sup>6</sup>Li + <sup>3</sup>He and <sup>3</sup>Li + <sup>3</sup>H, respectively

### **Participation of Ukrainian scientists in European thermonuclear research**

The analysis and processing of the data of deuterium-tritium (D-T) campaign on the world-largest JET Tokamak (Great Britain) was performed with the participation of researchers of the Institute of Plasma Physics of the National Scientific Center 'Kharkiv Institute of Physics and Technology' (NSC KhIPT). A new stable D-T discharge mode with the best plasma retention with-

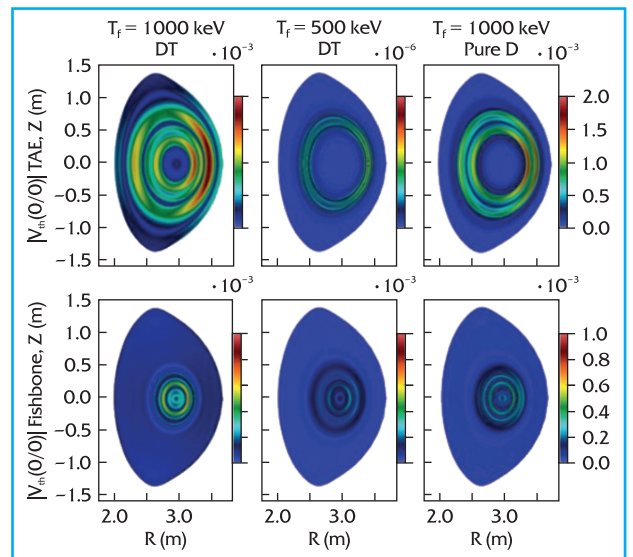

Zonal flows due to instabilities caused by high-energy particles

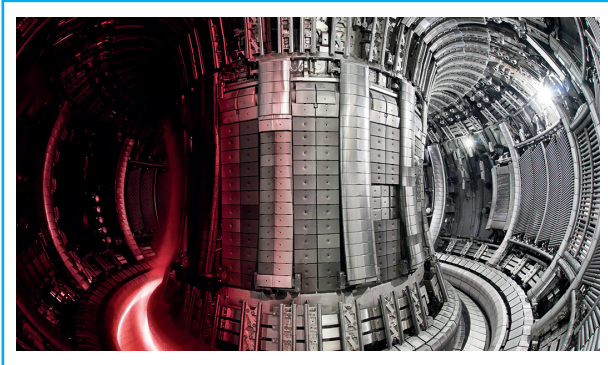

Joint European Torus (JET) Tokamak

out using additives with reduced energy losses as compared to D plasma was found. A better retention in D-T plasma was shown to be due to the presence of fast ions as well as *TAE* modes interactions with turbulence. Alfvén modes were experimentally investigated by researchers of NSC KhIPT and those of *TCV* (Switzerland) and *AUG* (Germany) tokamaks. This important achievement brings the commercial use of nuclear synthesis energy significantly closer.

*V. Moiseenko, M. Dreval, Yu. Kovtun*

### Calculation of stress concentration near openings in thin-walled elements of rocket structures made of nonlinear-elastic and viscoelastic materials, and assessment of the impact of stress concentration on the strength and fracture of these structural elements

The trend of using nonlinear-elastic and viscoelastic composite materials in rocketry forms an important direction in modern mechanics of deformable solids. This field focuses on developing deformation models that adequately represent real-world processes and designing effective methods for strength and fracture calculations of structural elements made from such materials.

Based on a comprehensive analysis of composite material manufacturing methods and experimental research on the nonlinear properties of orthotropic polymer composite materials, researchers at the S.P. Timoshenko Institute of Mechanics of the NAS of Ukraine have derived fundamental relations for the phenomenological theory of nonlinear elasticity of anisotropic materials, particularly for simple loading conditions. An efficient numerical methodology has been developed to solve physically nonlinear static problems for composite shell elements of aviation and rocket structures with openings. This methodology is based on the use of mixed functionals, Lagrange multipliers, simple iteration methods, additional stress methods, and mesh-based methods such as finite differences, variational-

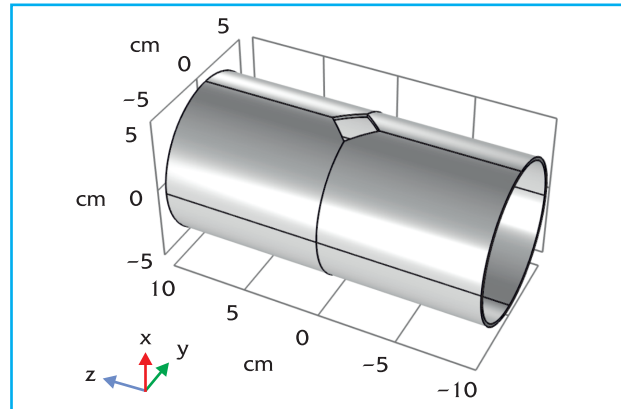

Computational model of a cylinder with a rhomboidal opening

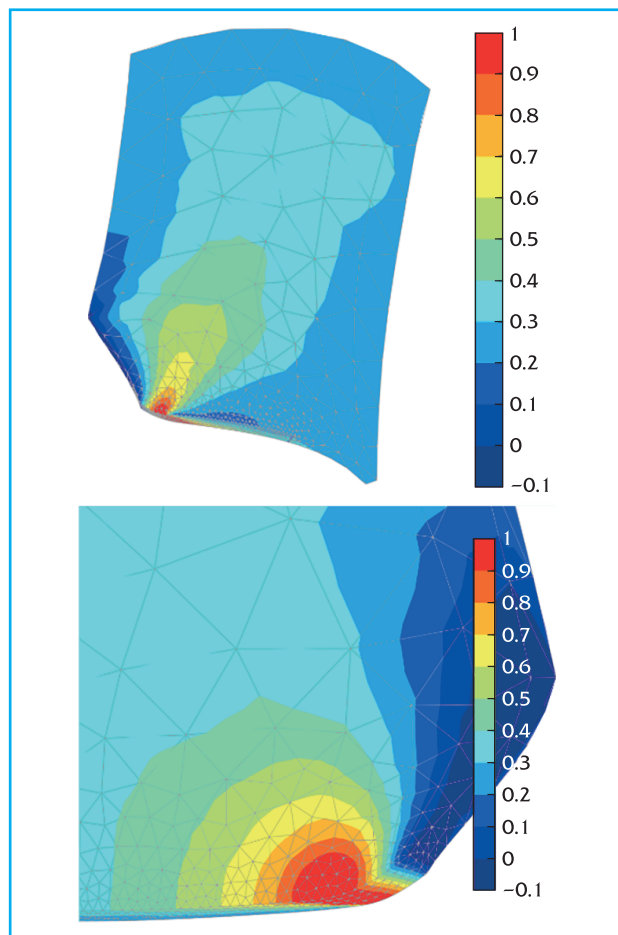

Deformed cylinder (with a magnification factor of 100) and the relative stress field at the moment of crack incubation completion.

difference methods, and finite elements. The proposed methodology employs both scalar and vector forms of geometric relations for the refined theory of moderately thick shells made from composites with arbitrary shear stiffness, including the limiting case of Kirchhoff-Love hypotheses.

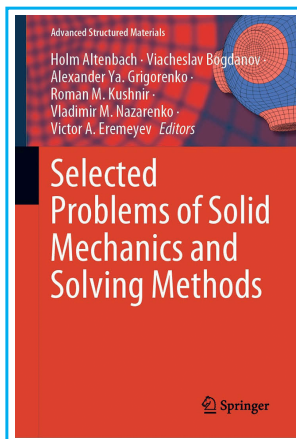

Collective monograph "Selected Problems of Solid Mechanics and Solving Methods" was published by the International Scientific Publishing House Springer under the editorial board of foreign member of the NAS of Ukraine H. Altenbach, NAS academicians V. Bogdanov, R. Kushnir, V. Nazarenko, and NAS corresponding member A. Grigorenko. The monograph presents over 20 chapters highlighting research results in the fields of plate and shell mechanics, fracture mechanics, thermoelasticity and thermo-plasticity, contact mechanics, and wave propagation theory

Using the developed methodology and the created software, the influence of nonlinear properties, shear stiffness, and the geometric and physico-mechanical parameters of the material on the stress-strain state of thin-walled composite elements of rocket structures — such as spherical, cylindrical, and conical components (e.g., fuel tank bottoms, interstage compartments, and transition sections of the first stage of a launch vehicle) with openings of various shapes — under high-intensity loading has been investigated. A number of new mechanical effects have been identified regarding the orientation of the orthotropy axes in the shell and the mutual influence of nonlinearity and transverse shear on the stress state of aerospace structural elements.

Besides, researchers at the Institute have developed and tested a method for predicting delayed fracture, characterized by the initiation and quasi-static propagation of normal separation cracks from stress concentrators. This approach integrates three key elements: the technique of incrementalization of constitutive equations, enabling accurate modeling of the long-term deformation of viscoelastic anisotropic materials; a cohesive zone model with a non-uniform traction-separation law as its foundation; and a criterion based on the critical work of cohesive tractions. The selection of these elements and criteria has been substantiated, and their synthesis into a unified computational procedure is presented.

The accuracy of the proposed method is verified through the study of Dugdale's classical crack propagation in an infinite plate, where an analytical expression for crack opening exists, and algorithms for deriving growth laws have been developed. In the two-dimensional case, the algorithm is applied to the study of delayed fracture for circular and rhomboidal stress concentrators. This approach has been extended to three-dimensional problems, including plates and shells with rhomboidal openings.

The conducted research has demonstrated the universality of the developed method, established the fundamentals of delayed fracture, and identified factors influencing the suppression of catastrophic failure in orthotropic viscoelastic structures.

I. Chernyshenko, M. Selivanov, V.A. Maksymyuk, E.A. Storozhuk, A.O. Kaminsky

### Numerical study of wave properties of three-dimensional elastic metamaterials

Scientific and industrial interest to metamaterials, which have artificially created regular structure, is explained by their unique properties: wave energy localization, negative refraction, and the ability to selectively suppress or even block the waves of certain frequencies. The properties related to destructive or constructive wave interference are enhanced in elastic media due to the emergence and transformation of various wave types.

A new type of metamaterials is produced by introducing periodically arranged thin-walled heterogeneities into an elastic matrix. As opposed to bulk fillers, thin-walled ones are placed in flat grids and cause spe-

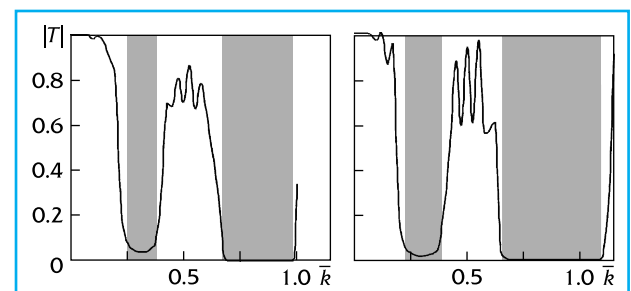
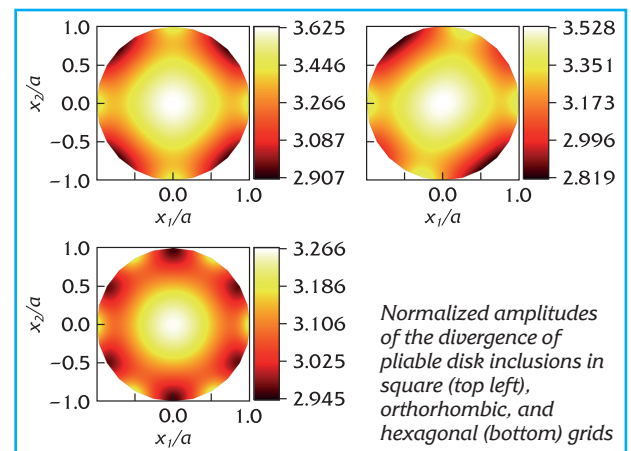

Wave blocking bands in the metamaterial with cascades of square (left) and hexagonal grids of disk inclusions on the frequency spectrum of the elastic wave transmission coefficient

cial effects of wave reflection and penetration. Numerical modeling is a high-performance tool of analyzing their elasto-acoustic properties.

At Pidstryhach Institute for Applied Problems of Mechanics and Mathematics of the NAS of Ukraine, in the framework of numerical modeling, limit-integral formulation was carried out and elements of limit-element discretization of problems on harmonic elastic waves propagation in 3D metamaterials with flat grids of periodic thin-walled cavities and inclusions were developed. The accuracy of limit-element analysis was confirmed by characteristic symmetries of the periodic solution obtained, which depend on the designs of 2D grids of thin-walled diffusers.

Coefficients of wave reflection and transmission in a metamaterial with a single grid of thin-walled diffuser were obtained by substituting limit-element solutions into the correlation that approximates the wave field distant from the grid array. For the case of multiple grids, these coefficients were determined both on the basis of a wide-area equidistant model of wave transport and by generalizing it to non-periodic cascade systems.

Numerical experiments were carried out with a view to simulating the wave behavior of elastic single-phase metamaterials with crack cavities, in which the role of wave resonator is played by the matrix (metal) material, and composite ones with wave interaction in the metal system "matrix — disk-shaped inclusions". The elastic wave frequencies at which the suppression of propagation through arrays of thin-walled heterogeneities, including low-frequency intervals of complete blocking, were determined. Demonstrated were the possibilities of controlling the widths of these bands by choosing cavity or material diffusers and their grid compactness, de-orthogonalization, in particular the transition to honeycomb pattern of the grids, as well as increasing the number of grids and changing their arrangement in the cascade.

The practical significance of the obtained results is the possibility of their direct use in the numerical interpretation of the data of ultrasound defect diagnostics and those of seismo-acoustic exploration of unconventional (finely dispersed) minerals, in designing functional vibration- and shock-absorbing metamaterials, in particular those for buildings and fortifications with increased elastic-resistance, for ultra-high-resolution phonon crystals and wave filters, etc.

The obtained results have become the basis for cooperation with *Luch* Design Bureau, which is aimed at computing the markers of wave attenuation in composite metamaterials for using those in damping structural elements of rocket and space systems.

*V. Mykhaskiv, I. Zhabdynskyi*

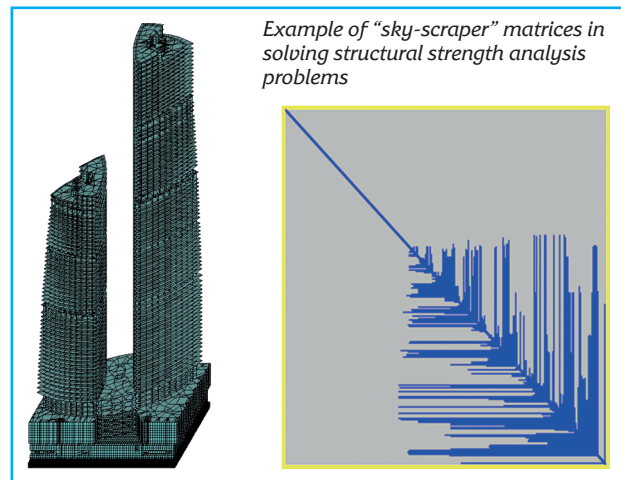

### Supercomputer mathematical modeling for construction industry

**G**lushkov Institute of Cybernetics of the NAS of Ukraine developed parallel algorithms for solving systems of linear algebraic equations, using block skyscraper matrices designed for distributed memory supercomputers.

Block sky-scraper data formats allow a reduction in the complexity of parallel computations. The algorithms are optimized for high performance, which makes them suitable for resource-intensive computing tasks. The results obtained were used for solving complex engineering tasks in construction industry, in electric welding, and at Max Planck Institute for Dynamics of Complex Technical Systems (Germany), significantly reducing computation time.

*O. Khimich, A. Popov, V. Sydoruk, O. Chistyakov, E. Nikolaevskaya*

### Accelerated resource tests of properties degradation in structural polymer materials of rocket and spacecraft products

**S**pecial-purpose spacecraft and Earth remote sensing satellites have been widely used recently. Most of them operate in very low orbits (~150—300 km). Atomic oxygen flows at this altitude are 2—3 orders higher than such flows at the altitude of 350 km. As a result, in very low orbits the rates of the degradation and destruction of polymers (spacecraft structural materials) increase significantly during long-term operation. Spacecraft operators lack the information and experimental (both satellite and bench) data on the degradation of polymer properties under conditions of their continued use at the altitudes of 150—300 km, which makes it difficult to predict the rates of their degradation and destruction. The problem can be solved by means of accelerated ground testing of resources on specialized benches.

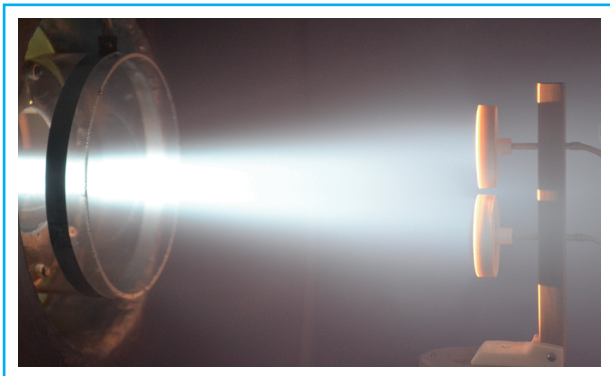

Samples of Kapton-H and FEP-100A polymers in atomic oxygen flow at the test bench of the Institute of Technical Mechanics

In particular, scientists of the Institute of Technical Mechanics (ITM), which operates under the NAS of Ukraine and the State Space Agency of Ukraine, have developed a method of accelerating resource tests of polymer structural materials used in rocket and space products in terms of their resistance to the prolonged action of destructive factors, such as high-speed flow of atomic oxygen ions and vacuum ultraviolet radiation in very low orbits. It was shown that irradiation of polymer samples with high-energy atomic oxygen ions ( $\sim 80\text{--}100$  eV), as well as the use of Kapton-H polyamide as a reference material provides approximately 1000-times acceleration of resource tests. Thus, the ITM plasma electrodynamic bench, which is included in the State Register of Science Objects that are the National Heritage of Ukraine, the annual environmental impact on polymers operating in very low orbits is studied in just 9 hours.

For the first time, a full range of thermo-optical and aerodynamic parameters was determined: mass loss, change in thickness, roughness, coefficient of the integral absorption of solar radiation, emissivity coefficient, as well as the accommodation of the normal and tangential momentum and the energy of atomic oxygen ions, which characterize long-term dynamic interaction of Kapton-H reference polymer with atomic oxygen in very low orbits in the Earth's atmosphere.

V. Shuvalov, M. Pismennyi, N. Tokmak

### Solid composite fuel produced from municipal solid waste and biomass

One of the tasks of the Waste Management Strategy in Ukraine is to increase the level of municipal solid waste (MSW) recycling, *viz.* to commission waste processing plants and set up facilities for producing fuel from MSW, which has high efficiency due to its high calorific value and less negative impact on the environment.

Scientists of the NAS Institute of Engineering Thermophysics NAS studied thermophysical and energy characteristics of MSW components of agricultural waste (corn and sunflower crop residues), of wood, peat, and experimental composite fuels based on them. Rational drying conditions, characteristic temperature values of the stages of thermal destruction, ashiness, heat of combustion and the rate of thermal decomposition of organic substances were determined.

It was established that 10—40 % varying of organic mass content in the fuel does not cause significant differences in thermal decomposition. The increase in polyethylene content raises fuel calorific value and intensifies the kinetics of light products release.

Thermal characteristics of experimental light composite fuels with lower heat of combustion (22.6—26.9 J/kg), which is 255% higher than the calorific value of wood pellets, allow these fuels to be recommended for production.

The developed technology of alternative composite fuel based on flammable components of municipal and agricultural solid waste ensures their effective use as a partial replacement of fossil fuels, as well as preserves and improves the environment.

Yu. Sniezkin, L. Voprobiov, V. Mykhailyk, T. Korinchevska, Z. Petrova

### Efficient electrocatalysts for organic flow batteries

L.V. Pisarzhevsky Institute of Physical Chemistry of the NAS of Ukraine proposed a simple and productive mechano-chemical method of obtaining effective nanocomposite electrocatalysts based on 2D chalcogenides of transition metals ( $\text{MoS}_2$ ,  $\text{MoSe}_2$ ,  $\text{WS}_2$ ,  $\text{WSe}_2$ ) and graphenes in the oxidation-reduction reaction of 9,10-anthrachinon-2,7-antracendisulphone acid (AQDS). It was discovered that, depending on the duration of the mechano-chemical treatment, both nanocomposites with component particle sizes of 50—100 nm and those of various morphologies can be obtained.

It was shown that mechano-chemical graphite stratification in the presence of ammonia makes it possible to carry out low-temperature doping with nitrogen and obtain graphene Gr-N particles with nitrogen content  $\sim 4.5$  at. %. Such graphenes manifest high electrocatalytic activity in the reactions of oxidation-reduction of 1,2 benzochinone-3,5-disulphone acid (BQDS) in the positive potential region.

Modification of graphite felt that serves as an electrode in flow batteries with particles of  $\text{MoSe}_2$  nanocomposites and graphenes causes a significant increase in electrocatalytic activity in the process of AQDS oxidation-reduction in the anode region of the potentials. Similar graphite felt modification with Gr-N particles

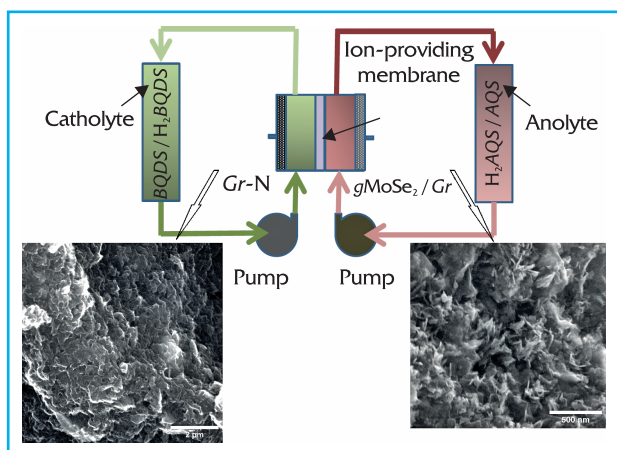

Schematic image of organic flow accumulator (the photos show SEM images of  $g\text{MoSe}_2/\text{Gr}$  and  $\text{Gr-N}$  particles)

produces a positive effect on the course of BQDS redox transformations in the cathode region of potentials. Due to that, mechano-chemically obtained materials can be used in the structures of electrodes of organic flow batteries, which considerably improves their performance.

Polarization curves and the peak specific power of a flow cell with the obtained modified nanoparticles of graphite felt electrodes can achieve  $12.6 \text{ mW}/\text{cm}^2$  under current load of  $35 \text{ mA}/\text{cm}^2$ , while the peak specific power of the cell with non-modified electrodes does not exceed  $5 \text{ mW}/\text{cm}^2$  under  $15 \text{ mA}/\text{cm}^2$  current. This indicates a significant electrocatalytic effect of  $g\text{MoSe}_2/\text{Gr}$  nanoparticles in AQDS redox reaction and those of  $\text{Gr-N}$  in BQDS redox reaction.

Usually, the energy efficiency of flow cell using non-modified electrodes does not exceed 35%, while introducing  $g\text{MoSe}_2/\text{Gr}$  and  $\text{Gr-N}$  particles increases this value to 70%. That is, graphite felt modification with  $g\text{MoSe}_2/\text{Gr}$  and  $\text{Gr-N}$  particles due to the formation of active catalytic centers is an efficient method of improving the performance of organic flow oxide-reduction batteries and opens up prospects of their application for accumulating and distributing energy from renewable sources such as solar and wind energy.

[V. Pokhodenko], V. Koshechko, O. Kozarenko

### Multi-phase UHF dielectrics with high Q factor and resonance elements based on them

Scientists of V.I. Vernadsky Institute of General and Inorganic Chemistry have developed and successfully introduced into production new types of ultra-high-frequency (UHF) materials. It has been established that multi-phase high Q-factor microwave dielectrics

( $\text{BaNi}_4\text{O}_9\text{-ZnO}$ ,  $\text{MgTiO}_3$  and  $\text{Mg}_2\text{TiO}_4$ ) synthesized under mild conditions demonstrate high Q-factor, temperature stability and the ability to adapt their properties by regulating the ratio of component phases.

Multi-phase high-Q factor UHF dielectrics and resonance elements were developed: "open" hemispherical dielectric resonators for the centimeter frequency range and coaxial dielectric resonators for the decimeter range. These materials were shown to be promising for creating the element base for 5G communication.

Institute's scientists synthesized microwave dielectrics used in developing various types of microwave resonators for manufacturing radio filters of different wave ranges, open resonators, and resonant blocks based on coaxial transmission lines with transversal electromagnetic (TEM) waves and waveguide transmission lines with waves of  $\text{H}_{10}$  type. Hemispherical resonators were created, whose radiation losses, due to their geometry, are smaller and less sensitive to external effects.

In particular, barium tetratitanate  $\text{BaTi}_4\text{O}_9$  modified with zinc oxide — an UHF dielectric — has high Q-factor ( $65,000\text{--}70,000$ ) and high temperature stability of its characteristics. It is important that less expensive reagents are used for its synthesis, and the process itself is simpler than that for materials with similar characteristics.

The research performed has proven that the end product contains two phases:  $\text{BaTi}_4\text{O}_9$  and  $\text{BaZn}_2\text{Ti}_4\text{O}_{11}$ . The dielectric properties of  $\text{BaTi}_4\text{O}_9$  in the microwave frequency range (10 GHz) demonstrate dielectric permeability  $\epsilon = 36$ , temperature coefficient of dielectric permeability  $\tau_\epsilon = -4 \times 10^{-5} \text{ K}^{-1}$  and the product of Q-factor and frequency  $Q \times f = 35,000$ .

$\text{BaTi}_4\text{O}_9$ -based ceramic resonators have negative temperature coefficient of resonance frequency, and  $\text{BaZn}_2\text{Ti}_4\text{O}_{11}$  is characterized with high Q-factor and positive temperature coefficient of resonance frequen-



Dielectric resonators for the frequency  $\sim 5 \text{ GHz}$  — cylindrical and hemispherical ones

cy.  $\text{BaZn}_2\text{Ti}_4\text{O}_{11}$  provides volumetric thermal compensation, which improves this material's thermal stability. By adjusting ZnO concentration, it is possible to change the overall thermal coefficient of the composite from negative to positive values, which is important for its practical application.

Using these materials, dielectric resonators of various shapes were produced, their frequency characteristics, which depend on the dielectric permeability of the substrate, were studied. Testing by the interested organizations proved the high potential of the developed materials for creating novel microwave appliances and devices that require high-quality UHF materials.

A. Belous, S. Solopan, O. V'yunov, L. Kovalenko, Y. Stupin, O. Fedorchuk, T. Plutenko

### Revealing the mechanisms of autophagy initiation in plants under microgravity

Researchers of the NAS Institute of Food Biotechnology and Genomics (IFBG) were the first in the world to describe the mechanisms of autophagy initiation in plants under microgravity. The term "autophagy" (Greek for 'self-eating') is understood as the process of removing leftover "debris" from the cell — the destruction of macromolecules, misfolded proteins, damaged structural components, old organelles, and other undesirable compounds in particular. The disposal process occurs in vacuoles. In any organism, autophagy occurs constantly, although with low intensity. The process is

activated by a number of stress situations, including starvation and various environmental factors. This provides organism adaptation to new conditions.

IFBG scientists experimentally proved that autophagy is involved in plant adaptation to changed gravity, and that the formation of autophagosomes — carriers of the used "waste" to vacuoles — is performed by such cytoskeletal structures as microtubules, whose main function is to ensure correct cell division.

The fact that plant growth and development directly depend on the correct functioning of the cytoskeleton helped track the patterns of changes not only in microtubule organization but also the expression profiles of all genes of their main protein — tubulin, as well as the genes of one of the essential autophagy proteins — ATG8, involved in forming autophagosomes under induced microgravity conditions. As a result of molecular genetic analysis, the key paralogous and non-paralogous genes, whose expression level increases significantly in response to this stress factor, were determined, as well as how and after what period of time the adaptive response of plants to gravitation change develops on the genetic and on the cellular levels.

The results of these original investigations are crucial for getting further insight into the cellular mechanisms of autophagy and involvement of cytoskeletal structures in autophagy biogenesis. They open up opportunities for developing practical ways of plant adaptation to space flight conditions.

A. Yemets, R. Shadrina, R. Blume, S. Plokhovska, Ya. Blume

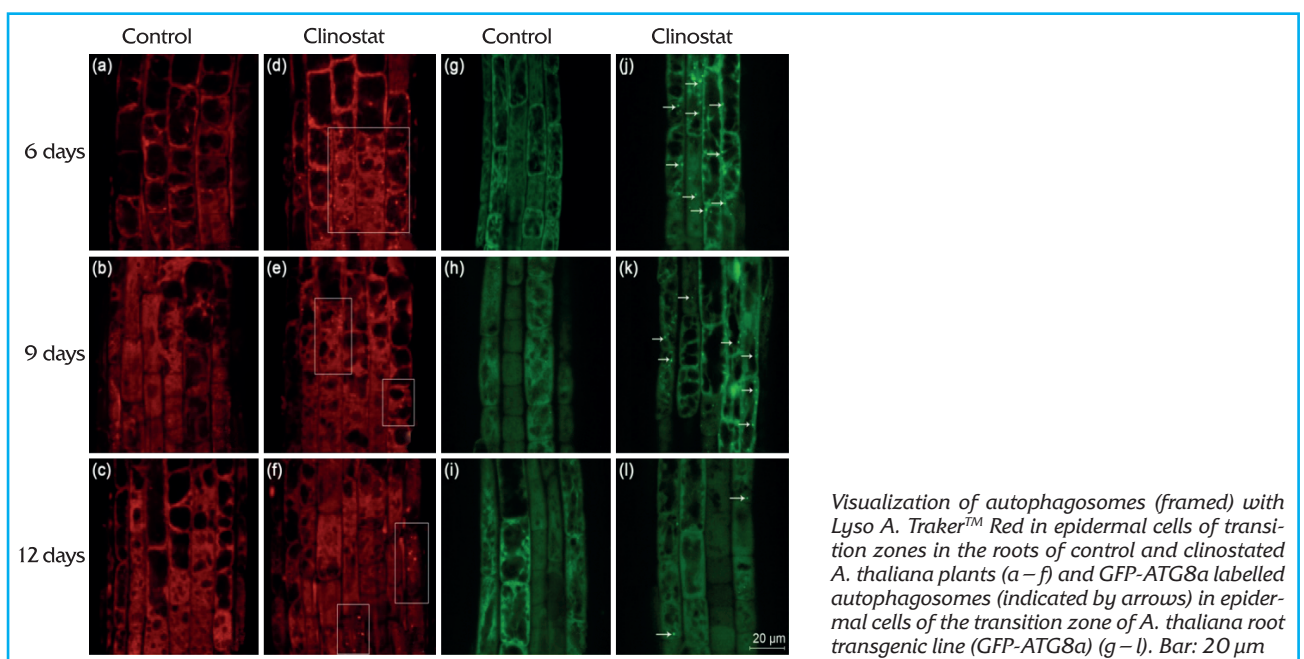

### The effect of photosensitive RuBi-nicotine on lung cancer cell proliferation

At Bogomoletz Institute of Physiology of the NAS of Ukraine, the first of its kind comparative study of the action of regular nicotine and its light-activated form, *RuBi*-nicotine was conducted. This is important for the development of pharmacological interventions with high specificity and minimal side effects, particularly for those for cancer chemotherapy. *RuBi*-nicotine, the ruthenium-bipyridine nicotine complex belongs to the class of photosensitive caged compounds whose active channel-specific component, nicotine, is a well-known agonist of ligand-gated ionic channels — nicotinic acetylcholine receptors (nAChR). Amongst the available caged compounds, *RuBi*-nicotine has the best photochemical properties, so it was used as a model compound for developing photopharmacological approaches. The advantage of membrane ionic channels as therapeutic targets is their accessibility from extracellular space, which eliminates the necessity for the drug to enter the cell through the plasma membrane. It was shown that both regular nicotine and that released from *RuBi*-nicotine in response to the irradiation with blue and green peaks in the spectrum cause similar long-term effects on human lung cancer cells: at low concentration it is proliferation, while at high concentration that results in apoptosis. The nicotine photoreleased from *RuBi*-nicotine can also activate the

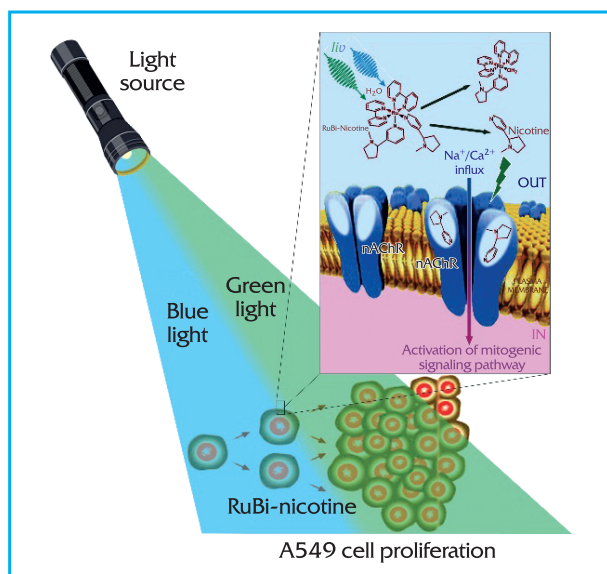

*Activation of the proliferation of human lung cancer cell line A549 by the nicotine released from its photosensitive caged RuBi-nicotine form in response to the illumination with blue-green light*

membrane current through the nAChR and cause the contraction of smooth muscle preparations of rat trachea. These results laid the foundation for further advancement of photopharmacology.

*Y. Shuba, I. Phylippov, G. Sotkis*

# RESEARCH ACHIEVEMENTS. SOCIAL SCIENCES AND HUMANITIES

Scholars of the Section of Social Sciences and Humanities of the NAS of Ukraine performed a significant amount of research into economics, socio-political and cultural development of Ukrainian society during the Russian Federation war against our country.

The team of scholars of the Section of Social Sciences and Humanities led by NAS academician S.I. Pyrozhkov prepared the National Report “**Preservation and Development of Ukraine in Conditions of War and Peace**”. This work is an attempt to answer the question of how the preservation and development of Ukraine in the wartime should be ensured and what a just peace for this country means in the conditions of forming a new world order.

The authors of the report systematically prove that Ukraine should be preserved and developed in geopolitical, demographic, economic, spiritual and cultural dimensions rather than merely defend its borders. Scholars consider Ukraine as the successor to the Kyivan Rus, assess the attitude of its citizens to the current status and development prospects of the Ukrainian state, determine the factors of forming the modern justice system, and specific features of judicial reform in Ukraine, formulate the tasks and potential of Ukraine’s post-war revival.

The report stresses that the national interests of Ukraine in the conditions of war and the establishment of a new world order are as follows:

- preservation and development of its people as a human community on the territory of the state that has a common culture and worldview values;
- preservation of Ukraine’s statehood and formation of a consolidated identity;
- ensuring the de-occupation and preserving the national territory of the state, which will make possible to use geographical, resource, historical, mental and other specific features of Ukraine as advantages in the country’s socio-economic development and in its international competition that has features of turbulence.

Today’s world understands that we strive for a *decent peace* rather than a peace at any cost and of any quality. In this striving we have the support of the democratic world, first and foremost, of the Euro-Atlantic civilizational community, which ever more realizes that our

righteous fight against Russian aggression is a struggle for values and identity both for Ukraine and for the whole civilized world, which professes democracy, humanism, human rights and freedoms.

The post-war Ukraine is to become an East-European center of dignity and justice, freedom and unity, it is to be built on the foundation of competitive economy, scientifically based environment recovery, efficient and humanistic management, holistic spiritual and cultural development that determines the preservation and development of civilizational subjectivity of this country and its human potential.

Ensuring national security must be the top priority in the development of the Ukrainian state. At the same time, it should be taken into account that the neighborhood with the Russian Federation will continue to be a constant threat for Ukraine.

*The leader of the team of authors is S. Pyrozhkov*

Scientists of the NAS Department of Economics obtained a number of pioneering results in studying the behavior strategies of Ukrainian people in war conditions. In particular, scientists of the Institute for Demography and Life Quality Problems of the NAS of Ukraine, with the UNICEF technical support, performed the **socio-economic survey of 8023 households**, which permitted the study of collective consumer behavior, modeling and prognostication of labor supply in Ukraine.

They were the first to develop the principles of studying consumer behavior based on a collective approach and propose a three-level system of models: collective (structural) microeconomic models for different household types; econometric (reduced) models of the relationships of household characteristics with their consumer behavior; micro imitation models for providing the possibility of modeling respective processes on the whole. The development and approbation of



modeling and prognosticating techniques in conjunction with combined mathematical statistics and micro imitation models of labor supply made it possible to determine a number of new patterns at the microlevel, in particular, to evaluate the size of economically active population, the reserves of increasing workforce supply and the situation on the labor market in general.

*L. Cherenko, V. Sarioglo et al.*

**S**cholars of the NAS Institute of the History of Ukraine completed publishing their work **“Ukraine. History Essays” in seven books** — the largest and the most complete new presentation of the national history from the ancient times to the present day.

The edition published in 2021—2024 offers a multifaceted and multilateral model of the historical process in Ukraine in the whole diversity of its local, regional and national manifestations. Nation- and state-forming components, as well as main markers of the Ukrainian identity, are emphasized as the consolidating factors.

The narrative is characterized by an innovative presentation of the history of primitive people in the geo-natural and socio-cultural environments, coverage of the transition from the prehistoric to historic times, as well as socio-cultural influences of the Antiquity World on the Northern Black-Sea Region. The history of Rus is presented from new viewpoints. The Lithuanian-Polish Commonwealth period in the history of Ukraine has found an original angle and conceptual treatment. The phenomenon of the National Revolution of the mid-17<sup>th</sup> century has been considered. The complex and multi-dimensional process of constituting and transforming the Ukrainian Hetmanate as an early modern state has been analyzed. A novel conceptualization and synchronous comparison of the evolution and progress of the history of Ukraine as a part of two empires — those of the Habsburgs and the Romanovs has been proposed.

New comprehension is given to the peculiar twists of the revolutionary events of 1917—1921, which reflected the fluctuations of national statehood and political projects from the left-socialist to the conservative-liberal one and vice versa. A modern conceptualization of the soviet/red project on the vast territory of Ukraine is presented through disclosing the distorted socio-cultural nature of the soviet regime and its repressive behavior.

The history of Ukraine during World War I, World War II and the Cold War is perceived and conceptualized in the context of the confrontation of great powers and their alliances, and in the opposition of the world systems.

Novel meanings are presented in the conceptualization of the current history of Ukraine against the back-



ground of entangled and extremely dynamic changeable present time. The elucidation of the Ukrainian project at the crossroads of current transformations, which are metaphorically defined as the post-totalitarian transit, helped reveal the causes and preconditions of the current Russian-Ukrainian war.

*Editor-in-Chief is V. Smolii*

**Book Two of the 9<sup>th</sup> volume of the “History of Ukrainian Literature” in 12 volumes**, prepared at Shevchenko Institute of Literature of the NAS of Ukraine was published. The volume presents the Early Modernism period in Ukrainian literature at the turn of the 19<sup>th</sup> and 20<sup>th</sup> centuries along with other phenomena and trends in the national belles-lettres of that time, the stylistic variability of Ukrainian literature, its consonance with the trends in the world belles-lettres and, at the same time, its national identity specified by the contemporary spiritual aspirations of Ukrainian culture and society as a whole.

The book presents the establishment of modernist trends in prose, drama, critics and literature studies and the accompanying literary and related cultural phenomena of that period. Provided is the information on the accomplishments of Ivan Franko, Lesia Ukrainka, Volodymyr Vynnychenko, Serhiy Yefremov, Vasyl Shchurat, Stepan Baley, Agatangel Krymsky, Osyp Makovey, Mykhailo and Oleksandr Hrushevsky, Mykola Voronyy, Mykhailo Mohyliansky, Gnat Hotkevych, M. Sribliansky Mykyta Shapoval), Mykola Yevshan (Fediushka), Mykhailo Yatskiv, Liudmyla Staritska-Cherniakhivska, Stepan Vasylichenko, Yakiv Mamontov, Spirydon Cherkasenko, Liubov Yanovska, Antin Krushelnitsky, Leonid Pakharevsky, Oleksandr Oles and others. The book concludes the review of literary and artistic events of 1900—1917.

# INNOVATIVE DEVELOPMENTS FOR THE NEEDS OF DEFENSE, ENERGY, MEDICINE, FOOD AND ENVIRONMENTAL SECURITY

## Light-weight and strong titanium-based composite armor

The development of light-weight armor bullet-proof and explosion-protective materials is especially relevant in the face of Russian aggression. To protect personnel and equipment, armored elements and combat accessories are made of steel, ceramics as well as high modulus Kevlar-type synthetic fabrics. However, these materials have certain disadvantages: steel armor is too heavy, Kevlar is limited in its protective properties, and brittle ceramic elements break after the first hit, which deprives of further protection.

Scientists of G.V. Kurdyumov Institute for Metal Physics of the NAS of Ukraine developed a novel type of armor materials with unique characteristics, which is based on light-weight and high-strength titanium. Its

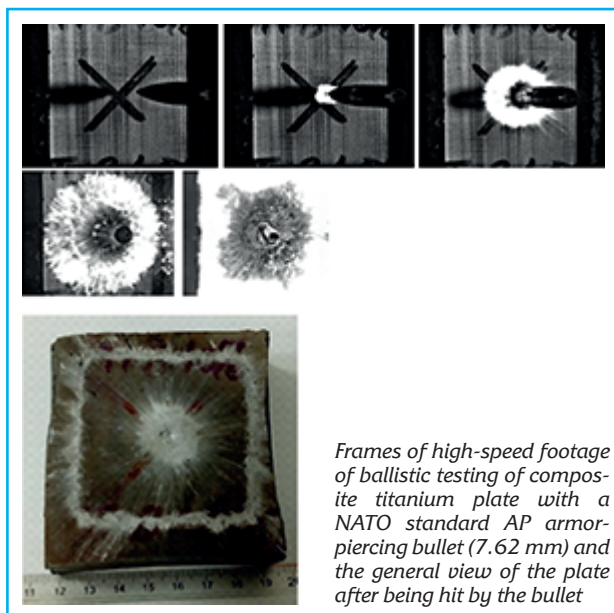

Frames of high-speed footage of ballistic testing of composite titanium plate with a NATO standard AP armor-piercing bullet (7.62 mm) and the general view of the plate after being hit by the bullet

key feature is a layered structure that contains frontal layers of hard high-strength metal-matrix composites based on 90Ti-6Al-4V (mass %), which are reinforced with TiC or TiB<sub>2</sub> hard ceramic particles, and back layers of lamellar titanium alloys. Due to such combination, high hardness (over 800 HV), strength and plasticity characteristics of the layered material are achieved, providing its extremely high ballistic resistance in armor-piercing ammunition tests. Taking into account the low specific gravity of this material, its armor protection properties exceed those of the widely known armor steels of the ARMOX type, and in terms of multiple-hit resistance, it is superior to ceramic materials.

To obtain layered structures, mixtures of hydrogen-saturated titanium powders were used with the application of hot isostatic pressing technology. It is important that the powder method of producing such armor provides a significant cost reduction, while achieving high protective characteristics and having half the weight of its steel counterparts.

*P. Markovsky, O. Ivasishin, D. Savvakin, O. Stasiuk, D. Oryshych, S. Prykhodko, V. Samarov, Ya. Yanishevskiy, B. Ficus*

## Technological schemes for producing anti-radar coatings and methods of their application

Researchers of Chuyko Institute of Surface Chemistry (ISC) of the NAS of Ukraine developed a multilayer anti-radar coating that provides masking properties in ultra-high frequency and infra-red ranges of electromagnetic waves. In accordance with the technical specifications, a technological scheme for the industrial production of anti-radar coating on metal surfaces was developed. The work was carried out with the use of advanced industrial equipment for producing special composite paints, weatherproof and high-quality varnish and paint components, fillers with dielectric, conductive and magnetic properties, devices and equipment for quality control of anti-radar coatings, as well as high-performance painting equipment.

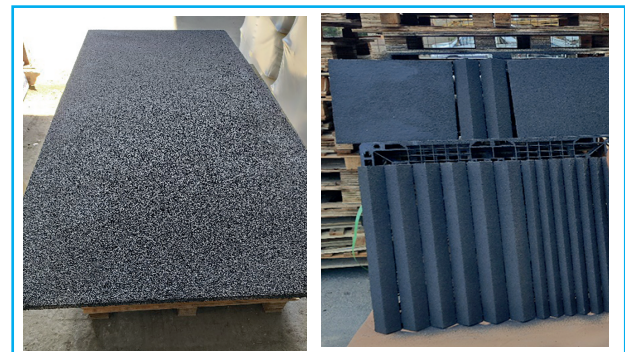

Anti-radar coatings on the specimens of various shapes and sizes

Pilot batches of anti-radar paints for creating layered coatings were produced. The technological process was carried out in accordance with the stages of the developed technological schemes, using the required equipment and raw materials. These paint products meet the terms of technical specifications and were used for producing prototypes of anti-radar coatings.

Methods of applying anti-radar paints on metal specimens (a total of 30 units), which were provided by the ISC of the NAS of Ukraine, were refined under industrial conditions as well. Specimen types and sizes were chosen in accordance with Ukrainian patent for a utility model № 154255.

Taking into account physico-chemical properties of the paints, optimal equipment was selected with the setting of individual modes for each layer of the anti-radar coating. Technological instructions for applying anti-radar paints were developed. Laboratory tests of the coatings showed that operation parameters of the industrially produced specimens were quite close to the reference ones produced in the ISC laboratory, which indicates a success in implementing the development.

*P. Gorbyk, S. Prokopenko, G. Hunia, K. Kalafat, L. Vakhitova, S. Bereznyi*

### **Lasers can blind and disable UAV systems**

**D**espite the fact that lasers have quite a wide range of reliable battlefield applications (as parts of rangefinders, munition guidance systems, etc.), they have not yet found wide use as a means of destruction, remaining "the weapon of tomorrow". However, changes in the development of methods and means of waging wars encourage reasoned consideration of lasers as an element of weapons based on new physical principles.

Over ten years ago, scientists of the NAS Institute of Physics focused on using the results of their own R&D, as well as the world experience in laser physics and engineering, for developing countermeasures against unmanned aerial vehicles (UAV) by disabling their video surveillance systems. These systems are most vulnerable to the radiation of lasers since they have an inherent property of focusing light on the material within the illuminated spot, which can be heated up to the melting point and even to evaporation and ionization, resulting in local damage of matrix structure and, ultimately, in matrix failure.

Studies of the effect of laser radiation with various energies and pulse duration on the video systems used in unmanned aerial vehicles, in particular in reconnaissance UAV (*Orlan, Supercam*), loitering munitions (*Zala, Lancet*) and FPV drones, helped determine its energy parameters for blinding and disabling UAV video systems at kilometer distances. Given the complexity of matrix structures, their spatial optical and elemental

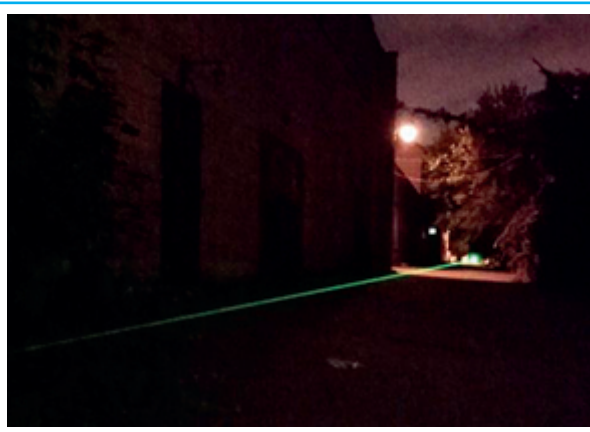

*Propagation of laser beams on the atmospheric path*



*Demonstration of video camera blinding by a laser*

heterogeneity, theoretical calculations of laser radiation parameters are not sufficiently reliable, therefore, experimental measurements are extremely important and useful. They showed that blinding or disabling of video surveillance systems is achieved by the lasers having battlefield characteristics that can be provided at the current stage of laser equipment development.

Relevant recommendations concerning laser radiation parameters, possible types of lasers for such applications were developed and transferred to interested organizations for use.

*A. Negriyko, L. Derzhypolska, A. Derzhypolskyi, I. Matsniev, O. Perederii, S. Khodakovskiy*

### **Prototype of a copter-based UAV complex for mapping mined areas**

**S**tate institution "Scientific Center for Aerospace research of the Earth of the NAS Institute of Geological Sciences" has developed an experimental prototype of the geoinformation platform (GIS) for detecting and mapping landmines and other explosive objects

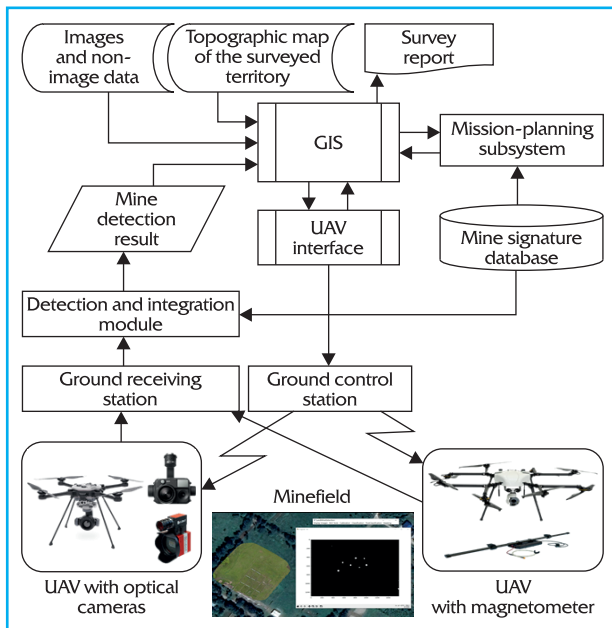

Structure of the united information platform for detecting and mapping landmines and other explosive objects by means of UAV

by means of UAV, which is based on the OGIS general-purpose open source geoinformation system. The proposed approach makes it possible to implement the above method into an end-to-end geoinformation technology for detecting landmines and other explosive objects with UAV, starting with aerophotography and ending with issuing the maps of the detected and documented minefields.

Besides the GIS itself, the geoinformation platform includes: the subsystem for planning the UAV mission, taking into account characteristics of the mines that are to be searched for; a software module for detecting landmines and other explosive objects, relying on probabilistic models, as well as used for integrating the detection results from different sensors; a special database with signatures and other characteristics of landmines that are used in the process of planning UAV photography and during landmine detection. The developed prototype of the system successfully passed field tests of multispectral, infrared and magnetometric UAV surveys of the studied plots with training and combat landmines located on them.

The results of estimation (the number of mines/detection accuracy/false alarm fraction) for different photography modes are as follows: multispectral photography — 93/0.957/0.226, infrared photography — 206/0.893/0.243, merging of multispectral and infrared photography results — 299/0.913/0.237.

M. Popov, S. Stankevich, S. Dugin, O. Tytarenko, I. Piestova, M. Lubsky, S. Golubov, A. Andreiev, A. Lysenko, T. Orlenko, E. Saprykin

## Innovative cable and wire products for critical infrastructure facilities of Ukraine

It is for the fourth year now that that Russian military aggression has exacerbated the problem of the stability of energy facilities to critical operating conditions and of their prompt replacement. Ukraine did not have relevant domestic technologies and industrial plants producing high-flexibility power cables for rapid restoration of destroyed power lines (PL), neither there were technologies and facilities to produce super-flexible wires for on-board electrical systems of airplanes, helicopters, tanks and armored personnel carriers.

Scientists of the NAS Institute of Electrodynamics, in cooperation with PIVDENCABEL PLANT private joint-stock company, in a short timeframe have developed novel technologies of special gradient electrothermal treatment of aluminum and copper conductive wires and structurally nano-reinforced ("cross-linked") polyethylene insulation, and launched the industrial manufacture of innovative cable and wire products (CWP) with increased flexibility for the critical infrastructure facilities of Ukraine.

Technologies of producing were developed and serial manufacture of innovative cables and self-retaining insulated wires with aluminum core of increased flexibility was launched for fast restoration of destroyed power lines and construction of new ones. These innovative electrical products with high added value are also exported to Sweden, Denmark, Norway, other Eu-



Cable and wire products: power cable and self-retaining insulated wires (below)

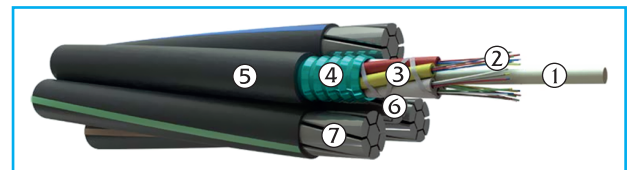

Next-generation self-retaining insulated wires combined with fiber optic cable: 1 - central power element of optical cable; 2 - optical fiber; 3 - optical module wiring; 4 - corrugated steel tape armor; 5 - protective shell; electrical wires: 6 - neutral wire; 7 - phase wires

ropean countries for building and restoring power lines in mountainous regions.

Economically sound solutions were elaborated and serial manufacture of domestic innovative cable and wire products was established, in particular military-purpose tinned on-board wires that are resistant to high-frequency vibrations, pulsed impacts, aggressive environments, pressure and temperature changes that emerge in on-board electric systems of special-purpose air and ground equipment.

The implementation of innovative Ukrainian CWP ensured the solution of strategic problem of re-equipping all Ukrainian power plants, and energy, mechanical engineering, transport enterprises, as well as those of military-industrial complex. To assess the compliance of those products with international standards IEC 60840 and IEC 62067, a specialized internationally accredited laboratory was set up. It has the right to test products of its own, as well as those manufactured by other companies, for international certification and obtaining permissions for their export to EU countries.

In 2024 the research was awarded with B.E. Paton Gold Medal of the NAS of Ukraine.

Anatolii Shcherba

### Producing finely dispersed powders of heat-resistant nickel alloys for 3D printing

Researchers of E.O. Paton Electric Welding Institute of the NAS of Ukraine have developed a technology for obtaining finely dispersed spherical powders of heat-resistant nickel alloys by plasma arc spraying of wire materials. It is based on new approaches to the processes of dispersing the sprayed material, where wires or rods (ingots) are used as source materials, while heating, melting and dispersing of the melt are carried out with high-speed/supersonic plasma jets without using centrifugal forces. This results in a considerable reduction in liquid layer size, rise in the frequency of drop separation and significantly increases the amount of finely dispersed fraction of the powder.

This technology of producing heat-resistant nickel powders provides:

- obtaining powders with high sphericity coefficient ( $>0.9$ ), with practical absence of irregular-shape particles, satellites, internal pores, etc;
- highly uniform distribution of particle sizes;
- in contrast to foreign and other domestic gas atomization technologies, this one provides for three times lower consumption of the atomizing gas (argon);
- the original design of plasma arc equipment, primarily of the spray chamber, permits the use of a gas flow directed towards the atomized particles, which makes it possible to control the intensity of their cool-

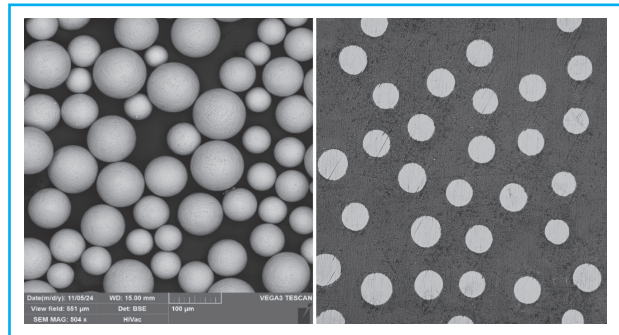

*Morphology (left) and microstructure of 4100 powder of Inconel 625 heat-resistant nickel alloy of 106 µm fraction, which was obtained in the process of plasma arc spraying*

ing and considerably reduce equipment dimensions (height).

The developed technology of producing powders by plasma arc spraying of wire materials will help to launch the domestic production of spherical powders of heat-resistant nickel alloys, promoting a wider use of 3D printing technology in aviation, aero-space and other industries, thus transferring additive production in Ukraine to a higher technological level.

V. Korzhyk

### Highly efficient engineering and technological solutions for increasing reliability and improving operational safety of underground mining facilities and other objects of critical infrastructure

Today, underground space is being actively developed for domestic and industrial needs: multi-level and multi-functional facilities of varying complexity are being created, comprehensive use of underground space is spreading in accordance with master plans for urban development. In this respect, Ukraine is no exception, especially under martial law as the use of underground structures for their primary and secondary purposes has increased significantly. First and foremost, this concerns the arrangement of structures as shelters for civilians during bombing and shelling. Adaptation of underground space to accommodate educational and medical institutions, production complexes, warehouses etc. is also of considerable importance.

The main types of underground structures that allow for additional use are mining workings, transport tunnels, underground premises of industrial enterprises, underground parking areas, basements in residential buildings. However, the repurposing of an underground structure for additional use increases the requirements for its technical condition. This is due to two factors: creating safe conditions for people who do not have special personal protective equipment, knowledge and

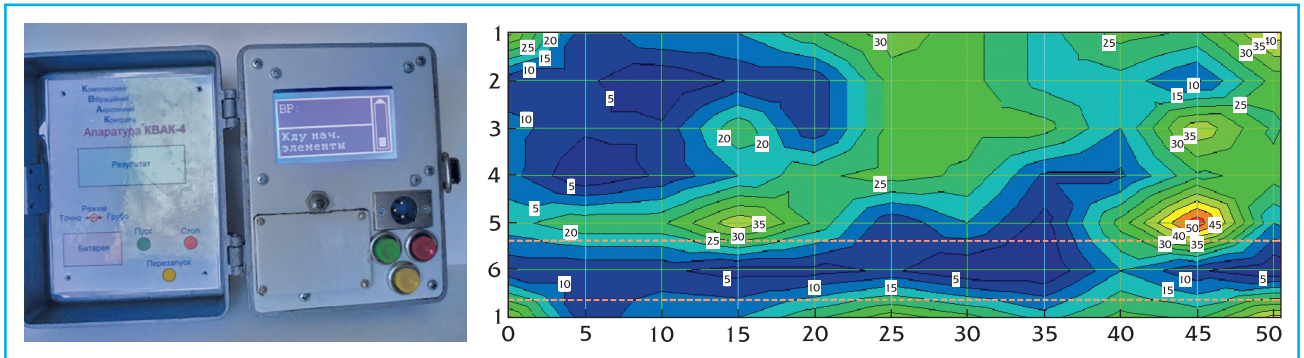

Vibroacoustic equipment KVAK-4 (left) and an example of the map of vibroacoustic diagnostics results

skills of underground behavior, as well as compliance with certain climatic regime for the placement of industrial equipment or arranging a warehouse. Therefore, using an underground structure for additional purposes necessitates a prompt assessment of its technical condition and timely completion of repair and restoration work to improve it and prevent possible accidents.

With a view to that, researchers of M. Poliakov Institute of Technical Mechanics of the NAS of Ukraine elaborated the “Methodological guide to assessing the technical condition of dual-purpose underground structures and developing comprehensive engineering measures of its improvement” for mining industry enterprises and underground infrastructure facilities that are or can be used for performing functions other than their primary purpose. The manual establishes the procedure of and general requirements to assessing the technical condition within the framework of national standards, regulates the procedure for performing repair work for a typical set of defects of a certain category of dual-purpose underground structures and concerns exclusively the stability of those structures and their ability to resist the effects of the geological environment.

It was established that the main types of visually determined defects are deformations and partially destroyed mining fastenings, surface corrosion of concrete and steel elements, water seepage into an underground structure. Besides, the rates of these processes for different conditions of structure operation were evaluated, which became the basis for a long-term forecast of its technical condition. For the category of defects than cannot be detected by visual inspection, a complex methodology for their quantitative and qualitative assessment by non-destructive testing techniques was developed.

Relying on the results of long-term observations of the dynamics of negative geo-mechanical processes in the “underground structure — geo-environment” system, taking into account foreign experience and in compliance with the requirements of the national

regulatory framework, criteria for assessing the technical condition of dual-purpose underground structures were elaborated in accordance with the recommended technology, with division into categories: ‘normal’, ‘satisfactory’, ‘unsuitable for safe use’, ‘emergency-prone’ ones. To improve the category of the technical condition of an underground structure with the purpose of its further use and performing additional functions, recommendations regarding repair and restoration works were developed. Technological features of their implementation in underground conditions were described in detail: rock strengthening by physico-chemical methods, sealing the cavities behind fasteners, concrete cementation, installing reinforced fasteners with metal elements, applying a penetrating coating, applying shotcrete with possible additional use of anchors and netting. The technology of these types of works is focused on using the best domestic and foreign construction materials and employing appropriate equipment. The assessment of the quality of performing certain types of work and the final assessment of the technical condition of the structure after repair are based on non-destructive testing methods.

Some elements of the technologies for assessing the technical condition and renovation of underground structures were successfully tested at several mines of Ukraine, hydropower and melioration facilities, industrial and civil underground structures.

*O. Krukovskyi, S. Skipochka, V. Serhienko, S. Musienko, L. Prohorets*

### Facilities for organic waste recycling as an element of distributed generation

Scientists of the Gas Institute (GI) of the NAS of Ukraine elaborated a technology of energy-efficient carbon dioxide extraction from biogas by means of an original solution of amine sorbents. That allowed a 1.5—2 times reduction in energy consumption as compared to conventional technology. The first in Ukraine biomethane plant was launched, pure products were obtained: biomethane (95%) and carbon dioxide (98%). Numer-

ous technologies of fuel gas management were developed: those of its preparation, purification, storage in liquefied and compressed states, and efficient use. A technology of electricity production from low-calorie landfill gas (with 30% methane concentration) was developed and widely implemented in industry.

The technology is comprehensive and solves two problems — those of energy and environment protection. The energy problem consists in using landfill gas as a fuel for generating electricity, heat, and producing commercial carbon dioxide; the environmental problem is the recycling of landfill gas for protecting the atmosphere, preventing greenhouse gas emissions and landfill fires.

With the direct involvement of GI, seven facilities of 7 MW capacity, in particular the first in Ukraine biogas power plant, were implemented. Due to it, over 100 MW of biogas-fired electricity generation was installed, 30 MW of that being on landfill gas. Generated and supplied to the electricity grid on a continuous basis was 1 billion kWh of electric power. The reduction in greenhouse gas emissions amounted to 5 million tons in CO<sub>2</sub> equivalent.

The technology developed is especially important in wartime since power generation from biogas works constantly, regardless of weather conditions, season, and fuel supply, is uniformly distributed over the territory of Ukraine, proportional to the number of local residents (waste generators and power consumers at the same time).

The potential of annual biogas generation from organic waste in Ukraine exceeds 10 bn m<sup>3</sup> in natural gas equivalent, which can fully provide local maneuvering capabilities and prevent power outages. As of today, all large solid waste landfills of Ukraine are provided with systems of landfill gas collecting and recycling. The next step is to install such systems at medium (50–300 thousand residents) and new landfills of municipal solid

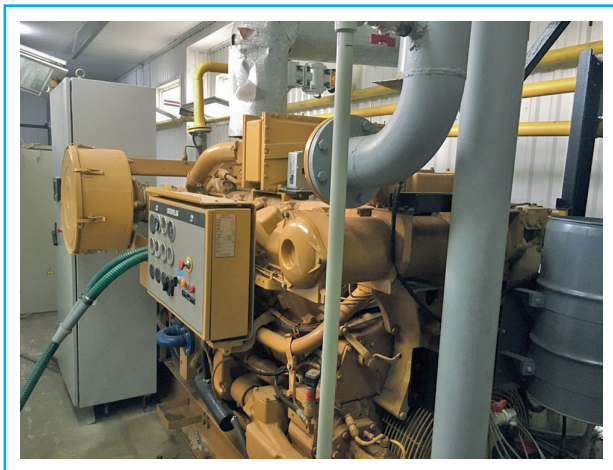

Generation equipment (electricity output is 500 kW)

waste (MSW), whose development is provided for by the National Plan for MSW management.

In 2024, this work was awarded with Borys Paton National Prize of Ukraine.

*H. Zhuk, S. Krushnych, V. Verbovsky, Yu. Ivanov, S. Kubenko*

### Graphite anodes for lithium-ion batteries with increased stability

**S**tabilization of the capacity of lithium-ion batteries (LIB) during operation is an important and relevant issue, especially due to their wide use in electric and hybrid vehicles. LIB capacity is determined mainly by the capacity of graphite materials, whose stability can be increased significantly due to producing composites of the “graphite core—protective shell” type.

At the NAS Institute for Sorption and Problems of Endoecology, a procedure for the accelerated studies of the layouts of “graphite—lithium” system semi-elements was developed in order to compare cycling stability of different anodes under full long-time loads.

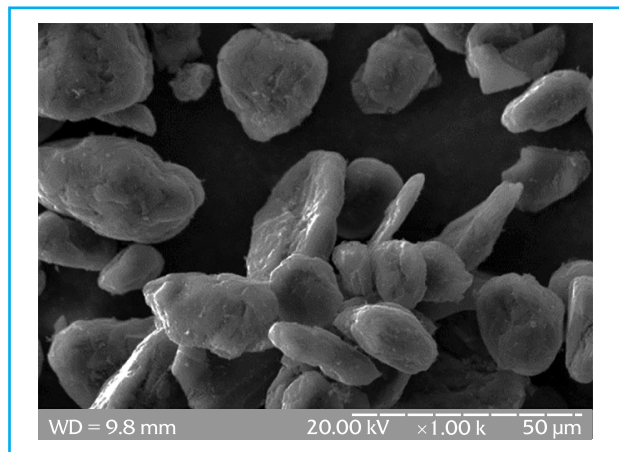

Structure of coated spheroidized graphite for lithium-ion batteries

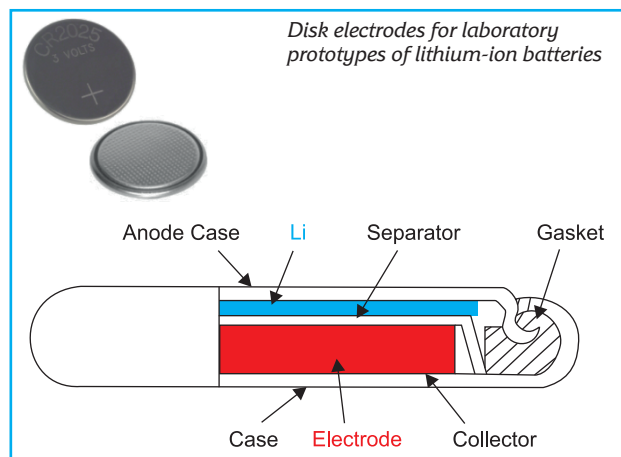

Studies of long-time cycling of three types of graphite anodes: natural graphite (GN), carbon-coated graphite (GN-C), and graphite with ceramic  $\text{Al}_2\text{O}_3$  coating (GN- $\text{Al}_2\text{O}_3$ ) have demonstrated that spheroidized natural flake graphite loses more than 18% of its original capacity after 100 cycles under 100% load. Further cycling leads to a rapid drop in capacity due to a fast growth in the thickness of the solid interphase film (SEI), which increases contact resistance between graphite and electrolyte. Carbon-coated graphite demonstrates considerably higher stability during cycling. The decrease in capacity after 100 cycles is about 8%. The rise in stability is due to carbon coating, which provides uniform electric current distribution in the porous electrode, reduces side reactions between graphite and electrolyte, slows down SEI film growth. Specimens of graphite coated with  $\text{Al}_2\text{O}_3$  ceramics demonstrate the best results in terms of cycling stability: reduction in capacity after 100 cycles does not exceed 6%. That is, ceramic coating effectively protects graphite surface against side reactions with electrolyte, preventing the excessive growth of SEI film.

*V. Barsukov*

### Methodology for thermal imaging control of gunshot and mechanical wound healing at the stage of rehabilitation treatment

Massive use of various means of destruction by the aggressor has become a characteristic feature of the current war. Suffering from shrapnel and explosive wounds are both fighters on the battlefield and civilians, who get numerous mechanical injuries by non-metallic fragments (glass, stone, wood, etc.) flying apart when hitting buildings and structures, and who also suffer from mechanical compression due to collapses

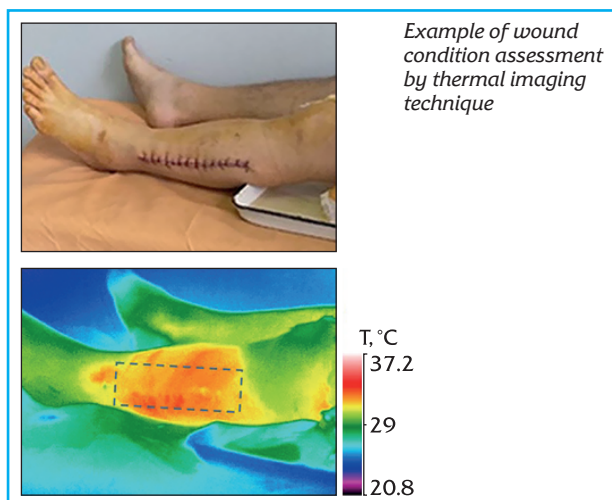

of those. Control of gunshot and mechanical wound diagnostics is one of the most pressing problems.

Scientists of B. Verkin Institute for Low Temperature Physics and Engineering of the NAS of Ukraine have developed the "Methodology for thermal imaging control of the process of gunshot and mechanical wound healing at the stage of rehabilitation treatment", which relies on infrared thermography as a non-invasive and remote technique of clinical visualization of damaged tissues. Since the process of wound formation is accompanied by inflammation (heat, redness, swelling, etc.), its amplitude and dynamics depend on many factors.

The developed procedure is based on remote measuring of the objective factor of temperature fields on the skin surface of a patient with a gunshot or mechanical wound and on further monitoring of wound condition. An original analyzer of thermal fields, which employs a microbolometric matrix with temperature sensitivity of  $0.07\text{ }^\circ\text{C}$  in  $8\text{--}14\text{ }\mu\text{m}$  spectral range, 1 milliradian spatial resolution, and 20 Hz frame rate, is employed for wound examination. The procedure was developed on the basis of the results of thermographic studies of wound-healing processes in patients undergoing reconstructive and restorative treatment in the burn unit of one of Kharkiv hospitals in 2023—2024.

The application of this technique provides quantitative wound care control, in particular the stages of engrafting the skin from a donor site, detecting the zones of inflammation, suppuration, necrosis and other complications, controlling microcirculation in scars and donor wound epidermis, etc. The proposed instruments make it possible to pass from subjective visual wound inspection to objective instrument-supported and non-invasive wound control, which provides more detailed and accurate information on wound healing and helps increase its effectiveness.

*G. Shustakova, Yu. Fomenko, E. Gordiyenko*

### Magnetic tool for minimally invasive surgery

Researchers of the National Scientific Center "Kharkiv Institute of Physics and Technology" developed an endoscopic magnetic instrument for removing foreign ferromagnetic objects from the pleural or abdominal cavity, with changeable inclination angle of its working part. It significantly helps to solve problems of minimally invasive surgical interventions. Prototypes of laparoscopic magnetic instruments for abdominal and thoracic surgery were developed and manufactured, taking into account the experience in practical use of experimental specimens. A pilot batch of the instruments was delivered to military centers of clinical medicine and civilian medical institutions.



Endoscopic magnetic instrument for abdominal and thoracic surgery, along with a set of magnetic endoscopic surgical instruments, which involves all developments in this area

The international recognition of this equipment was honoring the team of its developers with US Society of Military Surgeons Award — COL David G. Burris Prize for outstanding research achievements in traumatology and surgical intensive care (2024).

O. Velykodnyi

### Unique breeding materials for the first Ukrainian whole grain products with high antioxidant activity

Scientists of the NAS Institute of Plant Physiology and Genetics deployed the first in Ukraine program of creating unique breeding materials intended for obtaining varieties of colored wheat, spelt, and colored bare-grain food barley. That is an important new direction aiming at considerable improvement in the nutritional value of wheat grain and creating Ukraine's first whole grain products with high antioxidant activity. Grain color (blue, black, purple) is due to anthocyanin pigments (like those in colored berries, fruit and flowers) possessing high antioxidant activity which is even higher than the activity of other well-known antioxidants (resveratrol, quercetin, Trolox, ascorbic acid, selenium, etc.). Antioxidants are extremely important food components, they can neutralize aggressive free



Black grain wheat (left) and black bare-grained food barley



First Ukrainian whole grain products with 100% natural dark-brown coloring (without any colorants), produced by 'Billgrain' company from wheat varieties with purple grain and black grain spelt

radicals that cause severe pathologies: cancer, cardiovascular diseases, type 2 diabetes, etc.

The abovementioned program is aimed at creating genetic material with the "black grain" target trait, which combines blue color in the grain shell and purple color in the aleurone layer of grain and has the maximum content of antioxidants, the highest antioxidant activity of the grain and the derived properties of its processing. For large-scale and effective work on creating colored-grain wheat varieties, the only in Ukraine rich collection of source materials with purple, blue and black grain has been gathered in recent years. Black-grain wheat varieties (which are listed in the State Register of plant varieties of Ukraine) were created, as well as the first in Ukraine spelt with dark purple grain. The production of wholemeal flour from colored wheat and colored spelt was established, along with that of numerous functional, healthy and

tasty whole grain products with 100% natural dark brown coloring. Also initiated was the production of functional foodstuffs (cereals, flakes) from black-grained food bare-grain barley. These 100% whole-grain products had not been previously available at the food market of Ukraine.

*V. Morhun, O. Rybalka*

**General approaches to revitalizing war-affected rivers (as exemplified by the Irpin river)**

Researchers of the NAS Institute of Hydrobiology systematized the effects of military operations on the Irpin River catchment and developed general approaches to and a technology for revitalizing the rivers affected by the war. The inventory of surface water bodies of the basin revealed disturbed river sections, as well as those that are important for biodiversity conservation, determined the locations and hydrotechnical waterworks in need of restoration.

The generalized assessment of the ecological condition of the Irpin River water bodies according to the "Procedure for State Water Monitoring" showed the absence of the areas with "excellent" ecological condition. Essential structural changes in benthic macroinvertebrate and fish communities were detected near the town of Gostomel and Romanivka, Gorenka, Moshchun villages, as well as in the mouth of the Irpin River, where the dam near Demydiv village had been blown up.

A list of ecosystem services within the defined surface water bodies of the Irpin River was compiled. Ecological services 'Habitat provision' and 'An obstacle to the advance of enemy troops', which help determine potentially impassable river sections and waterlogged floodplains in the Irpin River basin for deterring troops advance, as well as preserving sections of such rivers as biodiversity reserves.

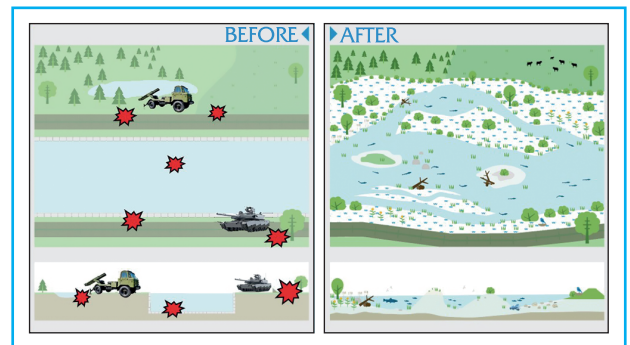

*Scheme of the channelized section of the Irpin River that had been affected by hostilities before and after revitalizing measures*

**Measures aimed at revitalizing the channelized section of the river that suffered from hostilities**

Measures	Obtained benefits
Moving dams further away from the riverbed	Creation of a wide corridor for riverbed development and free meandering
Reducing the intensity of land use on the adjacent territory	Emergence of new riverbed shapes Transportation and accumulation of the necessary amount of alluvion in the riverbed
Restoring old riverbeds or constructing new arms	Promoting the emergence and growth of the necessary number of aquatic plants

These hydro-morphological and hydrobiological studies provided the grounds for identifying eight river sections that play a vital role in the functioning of water and floodplain ecosystems as biodiversity reserves.

*S. Afanasyev*

# INTERNATIONAL COOPERATION IN THE FACE OF CURRENT CHALLENGES

In 2024, a series of visits and international meetings took place, where Academy leaders presented the achievements of Ukrainian science, discussed the problems of its functioning, along with possibilities and ways of dealing with them.

**At the meeting of the presidents of the academies of sciences of member states of the Black Sea Economic Cooperation Organization (BSEC) and rectors of leading universities of the Turkish Republic**, which was held on 14—15 February in Istanbul on the initiative of the Parliamentary Assembly of the Black Sea Economic Cooperation (PABSEC), its participants informed about the current activities of their organizations and institutions. During a constructive discussion they exchanged views on a wide range of collaboration issues in science and technology between countries of the Black Sea Region. In his presentation, NAS President Anatolii Zagorodnii noted the clear position of all academies of sciences of the BSEC member countries and leading Turkish Universities on the war in Ukraine and their unwavering support to the Ukrainian academic community. He also assured that the NAS of Ukraine highly appreciates the efforts of foreign colleagues towards further development and deepening the mutually beneficial cooperation in the sphere of science and technologies.

**In his report at the Transatlantic Big Science Conference**, which gathered international science leaders, researchers and professionals in various science areas on 27—28 June in Berlin, NAS President stated that sci-

ence in Ukraine continues to develop in conditions of full-scale Russian military aggression, takes measures towards integration to the European scientific area, proactively cooperates with its Western partners and the EU countries in the framework of global transatlantic scientific projects, multinational consortiums and international scientific collaborations. He also stressed the necessity of reformatting the international aid in order to support the scholars who are working in Ukraine. It was emphasized that the achievements and functioning of Ukrainian science during the war is a vivid example of resilience and perseverance of scientists amidst current crises.

An important result of the conference was the fact that its participants confirmed their willingness to provide the necessary aid and assistance to Ukrainian academic community, deepen international cooperation in the sphere of science for security and economic development of Ukraine, its integration to the European science area. Comprehensive support to science in Ukraine was one of the main recommendations of the conference and was officially included in its conclusions.

**The tripartite international scientific meeting of the representatives of Great Britain, Poland and**



*President of the NAS of Ukraine addresses the representatives of OBSEC member countries and stresses the necessity of making every effort to achieve sustainable peace based on the independence, sovereignty, and territorial integrity of Ukraine*

*Destroyed and damaged infrastructure of Academy's research institutions (report of the NAS President at the Transatlantic Big Science Conference)*

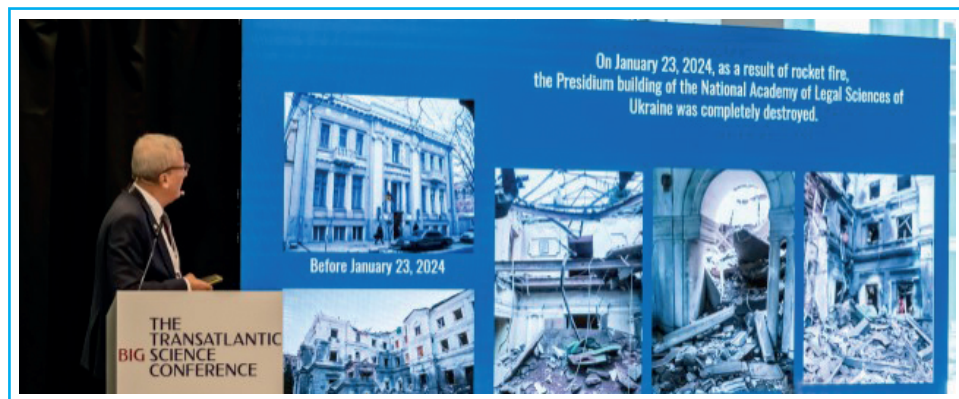



*Helen Ronlund, Director-General of the Swedish National Museums of Military History, at the NAS Institute of Ethnology*

**Ukraine**, which was organized by the Royal Society of London, Polish Academy of Sciences and the National Academy of Sciences of Ukraine on 14–16 October in Warsaw was of interdisciplinary nature and aimed at uniting experienced scholars and capable young researchers for informal communication, discussing and clarifying prospects of potential cooperation in the area of mathematical sciences. In the welcome speech, the Academy President spoke about the history of Ukrainian mathematical school and its achievements, outline the range, current status and problems of mathematical research, emphasized the great importance of mathematical sciences in establishing current scientific world view.

A number of visits of foreign colleagues to the NAS of Ukraine and its institutions also took place.

**On 6 February, The National academy of Sciences of Ukraine was visited by a delegation of the Ministry of Science and Higher Education of the Polish Republic.** Andrzej Szeptycki, Deputy Minister of Sci-

ence and Higher Education of Poland, named four key elements of cooperation of the Ministry of Science and Higher Education of Poland and Ukraine: further aid to Ukrainian academic community; strategic cooperation at the level of people and institutions; development of mutually beneficial cooperation in various science areas; assistance in developing the European future of Ukraine.

**On 15 April the NAS Institute of Ethnology was visited by Helen Ronlund, Director-General of National Swedish Military History Museums.** During the meeting, Ms. Ronlund and her Ukrainian colleagues discussed further cooperation steps in the sphere of culture, which would be instrumental in debunking Moscow's propagandist myths and strengthening Ukraine's subjectivity on the world arena.

On 7 August the Academy was visited by a delegation of the US National Academy of Sciences. Vaughan Turekian, Executive Director of the Department of Politics and Global Affairs, informed its participants that in the framework of a new initiative the US National Academy of Sciences started a multi-million Science and Innovation Fund for Ukraine with the purpose of providing support for Ukrainian research community and setting up an innovation system that would promote the advancement of national security, economic recovery and investments. He also noted that this system is to ensure strengthening the relations of Ukrainian scientists with American and world S&T community.

**On 2 October, a delegation of the largest German research center of basic sciences DESY (Deutsche Elektronen-Synchrotron) paid a visit to Bogolyubov Institute for Theoretical Physics of the NAS of Ukraine.** German colleagues met with Ukrainian researchers in the fields of high energy physics, astrophysics and cosmology with a view to strengthening contacts, outlining common scientific interests and discussing the opportunities of future cooperation.

In the framework of the visit of Federal Minister of Education and Scientific Research of Germany Bettina Stark-Watzinger to Kyiv in October, there was a presentation of four Ukrainian-German centers of advanced



*Demonstration of support to UNESCO Programme for freedom and safety of scientists by participants of the 219<sup>th</sup> session of the UNESCO Executive Board*

research, which are one of the key initiatives of S&T cooperation between Ukraine and Germany. Such centers were set up with the participation of NAS institutions: Institute of Cell Biology and Genetic Engineering, Institute for Scintillation Materials, Kyiv Academic University and I.M. Frantsevich Institute for Problems of Materials Science. The activities of the centers where Ukrainian and German scientists will collaborate in research and development of advanced technologies are carried out with the financial support of Germany.

Academy scholars took part in the work of several international forums: the 219<sup>th</sup> session of UNESCO Executive Board (Paris, France), the 42<sup>nd</sup> session of the Inter-Agency Space Debris Coordination Committee (IADC, Bangalore, India), the 61<sup>st</sup> session of the Intergovernmental Panel on Climate Change (IPCC, Sofia, Bulgaria), the European Corrosion Congress—EUROCORR-2024 (Paris, France), the 35<sup>th</sup> International Geographical Congress (Dublin, Ireland), etc.

**The 219<sup>th</sup> session of the UNESCO Executive Board** on 19 and 26 March 2024 held meetings with presentations, discussions and approvals of the UNESCO's programme on the promotion of scientific freedom and the safety of scientists. The members of the Executive Board approved by majority vote the version of the final document containing the proposals of the NAS of Ukraine. It decidedly supported the need to "prioritize the protection of the safety and freedom of scientists in the context of broad efforts for the protection and preservation of science *in the cases of any conflicts and emergencies, including scientists forcibly displaced under such circumstances*, and define specific measures in this respect within UNESCO activities in those spheres". In accordance with the results of the session in discussing and approving the Report on the implementation of UNESCO measures and the Programme of emergency assistance to Ukraine, it was decided that UNESCO would consolidate efforts towards mobilizing extra resources and establishing partnerships for providing support to the recovery of cultural, educational and scientific infrastructure of our state.

Numerous programs in support of Ukraine's scholars launched by the governments, scientific centers, academies of many countries at the beginning of the Russian armed aggression are now continued. At the same time, new grant competitions were launched for Ukrainian scholars. For example, **the Federal Ministry of Education and Scientific Research of Germany** announced the 'Competition to finance German-Ukrainian scientific cooperation for sustainable recovery'. The purpose of the competition is to support Ukraine's scientific environment and preserve its research potential. It was assumed that in the framework of this competition German and Ukrainian institutions will work together on the R&D topics that are of common interest.



*Speech of Viacheslav Oleshchenko, head of the Ukrainian Geographical Society, at the General Assembly of the International Geographical Union*

The terms of the competition provide for supporting and developing research potential in Ukraine by transferring part of the funding to a partner institution in Ukraine.

**U.S. Civilian Research and Development Foundation (CRDF Global)** held competitions for grant support to attending international scientific events (conferences, seminars, trainings, etc.) and publishing papers by Ukrainian scientists, technical specialists and engineers who work in chemical, biological, radiological, nuclear and adjacent R&D areas.

**Central European Research Infrastructure Consortium (CERIC-ERIC)** informed about launching new competitions for the access to state-of-the-art equipment to carry out comprehensive studies, interdisciplinary ones in particular, in materials science and biomaterials. The access to CERIC-ERIC infrastructure is open and free for scientists from Ukraine on condition that the results and data obtained will be available to the community in accordance with the Scientific Data Policy.

Another important form of the support to Ukrainian science became **physics schools for young researchers, DESY-Ukraine in particular**. The second such school started in July of the reporting year. For six weeks 25 Ukrainian students were listening to the lectures of leading scientists and prepared scientific projects.

**Research4Life project** extended free access to its resources for Ukraine to 2025. Through the *Research4Life* portal Ukrainian institutions have the right to access full-text e-books and journals of the international publishers *Elsevier, Springer Nature, John Wiley & Sons, Taylor & Francis, Emerald, Sage Publications, Oxford University Press, Cambridge University Press, IOP Publishing*, etc.

Active work of Academy scientific teams in international programs did not stop.

The successful implementation of 14 long-term projects under **NATO 'Science for Peace and Security' Programme**, in the framework of which Ukrainian scientists conducted research of applied nature. Many projects provide for developing products for defense purposes.

S. Subbotin Institute of Geophysics of the NAS of Ukraine initiated the project *MinesEye — UXO identification and classification for Ukraine*, which is aimed at accelerating the process of demining territories, employing UAV in combination with ground drones during detection and identification of unexploded ordnance. The results of fulfilling the project will provide for the development and implementation of a system for detecting such ordnance in terms of various critical characteristics, i.e., the speed of detection and identification of the objects searched for and the general assessment of the system performance.

The cooperation under 47 projects of the **EU Framework Programme for Research and Innovation Horizon Europe and the EU Programme for Atomic Energy Education and Research (Euratom)**, which is complementary to *Horizon Europe*, was successful as well.

In particular, the infrastructure project **Astrophysics Center for Multimessenger studies in Europe (ACME)** was launched, with the involvement of researchers of the NAS Radio Astronomy Institute, scientific institutions of Belgium, Finland, France, Germany, Great Britain, Greece, Italy, Latvia, the Netherlands, Poland, Spain, Switzerland. The project is aimed at *ACME* expansion for providing wider, simplified and more effective access to the best research infrastructures for scientists working in the fields of astronomy and elementary particle astrophysics. *ACME* will be the basis for strengthening long-term cooperation between research infrastructures regardless of their location.

In the framework of **EURIZON programme** with the budget of € 4.5 million in the reporting year, 60 scientific projects were supported in Ukraine. Besides, *EURIZON* programme provides for scientific equipment transfer for the recovery of Ukraine's research infrastructure. The first batch of scientific equipment from *CERN* in the framework of the *EURIZON* initiative arrived in Kharkiv in December 2024. It is worth noting that this program is aimed at supporting Ukrainian scientists who continue working in Ukraine.

The implementation of three projects under the programs *Interreg-EU* the Danube Region and *Interreg-NEXT* the Black Sea Basin was started. The Ukrainian Hydrometeorological Institute, operating under State

Service for Emergencies and the NAS of Ukraine, as a part of the consortium of 13 European states with Vienna University of Technology (Austria) at the head, became the executors of the project **Coordinated Danube Action for the Titanic Endeavor of Tackling Hazardous Substances water pollution under changing pressures, challenges and targets —TETHYS** in the framework of Programme *Interreg-EU* the Danube Region. The project is to address the problem of water bodies contamination with hazardous substances through a complex of measures, namely: planning the monitoring and chemical analysis; data management and a set of instruments for data analysis; emission modeling and risk assessments. Such an approach will be harmonized for joint implementation and adapted to national specifics. The implementation of *TETHYS* project will help fill significant gaps in the knowledge level, the ability and availability of effective instruments within the Danube Basin countries — both EU members and those outside it.

**Five National Contact Points (NCP)** of the EU Framework Programme for Research and Innovation *Horizon Europe* and Programme for Research and Education of the European Atomic Energy Community (*Euratom*), which is complementary to *Horizon Europe* Programme, hosted by NAS institutions, started their work. The main task of NCP network is timely informing the scientific community of Ukraine about the announced competitions, informing it on the general requirements of those competitions, providing assistance in preparing and submitting applications for wider involvement of Ukrainian institutions and organizations, as well as increasing the level of applications of Ukrainian scientists for participation in EU competitions.

An important step towards expanding the circle of partners was signing the **Memorandum and Agreement on cooperation between Henrich Heine University Dusseldorf (Germany) and the Institute for Functional Materials Chemistry of NTC Institute for Single Crystals of the NAS of Ukraine**. On 5 November 2024, the parties to the memorandum defined the areas of interaction, namely: joint research activities, exchange of scientific materials, academic publications and information; exchange of scientists for conducting research, lectures and discussions; exchange of post-graduate and doctoral students for training and research; joint organization of and participation in lectures, seminars and conferences; cooperation in administration issues, etc.

# SCHOLARS COUNTERACT THE “Russian world” IDEOLOGY AND ENEMY’S PSYOPS

Like in the previous years, counteracting the ideology of the “Russian world” with the provable deconstruction of myths and deliberate falsifications of the former and current Russian historiography is an important element of the studies of NAS scholars in socio-humanities.

Back in 2022, with the beginning of the large-scale war of the Russian Federation against Ukraine, researchers of the Institute of the History of Ukraine founded a thematic series of scholarly and popular-science publications “Current Russian-Ukrainian War in History Coordinates”, in which they disprove Russian imperial representation of Ukrainian history, reveal ideological origins of Russian imperial aggression against Ukraine.

In 2024, a number of books were published in this series, in particular:

“Worldview Matrix of the *“Russian World”*: Genesis, Components, Internal Contradictions, Problems of Dismantling” (Larysa Yakubova);

“Rashism: Genesis of the Concept and the Phenomenon” (Larysa Yakubova);

“Commemorative Policy of the Russian Federation as a Means of Preserving the “Empire”” (Oleksandr Ly-senko);

“Current Ukrainian Historical Narrative as a Means of Deconstructing Russian Historical Propaganda” (Oleksandr Udod);

“Current Russian-Ukrainian War in the Light of Historical and Socio-Humanitarian Knowledge” (Oleksiy Yas).

The materials related to refuting aggressor’s myths concerning the “ahistoricity” of Ukraine and its absence in the European geopolitical and cartographic space in the historical retrospect, were publicized in issue 18 of Institute’s professional collection of articles “Historical Geography Studies in Ukraine” (its editor-in-chief is Rostyslav Sossa).

In the monograph “Ukrainian-Russian Borderland in the Space of Identities Conflict in History and Contem-

poraneity”, the genesis of the territory and identification oppositions on the Ukrainian-Russian borderland, the development and implementation of the system of information and culture security as a possible resource for the Ukrainian society deconflictization and reintegrating the population of the occupied territories was grounded (Yaroslava Vermenych).

Professor Stanislav Kulchytskyi in his book “Leninist System of Power and Ownership in Occupied Ukraine. 1917—1923” analyzed Russian communo-socialism and its implantation in Russia and Ukraine. He proved that Leninist communo-socialism had nothing in common with the European socialism except Marxist phraseology but it found support among common people gripped by “unconscious socialism”. Lenin and his successors created a totalitarian construction of power and ownership by means of triple expropriation: that of the bolshevik party — by its leaders; of the soviet state — by the bolshevik party; of the society — by the soviet state.

NAS corresponding member Larysa Yakubova made a presentation “Rashism: Challenges of Public Interpretation, Scholarly Conceptualisation, and Memorialization” at the international scholarly and practical conference ‘Bykivnia, Babyn Yar, Bucha — Between the Massacre and Memory about it’ (Berlin, 25 November 2024); took part in the discussion ‘Genocidal practices of the RF in Ukraine: from Holodomor to Russian-Ukrainian war’, which was organized by the Main Intelligence Directorate of the Ministry of Defense of Ukraine (Kyiv, 25 November 2024); made a speech at the panel discussion ‘1000 days of resistance: war, truth, identity’, organized by the Donoblippe (Kyiv, November 19, 2024); delivered a public lecture ‘Crimea and Ukraine: how to present the history of the Crimean Tatars and their deportation’.

The website of the State Institution ‘NAS Institute of the World History’ launched a rubric ‘The war of Russia against Ukraine’, where scholarly prognostic and counter-propaganda materials were placed: the analysis of the politics evolution in the leading countries of the world, international organizations, influential international leaders on the issues of issues of counteract-





ing the Russian aggression against Ukraine, providing international support to Ukraine. The monograph “Rashism: License for Genocide” (Vasyl Tkachenko) was published.

Scholars of Kuras Institute of Political and Ethnic Studies of the NAS of Ukraine and M.S. Hrushevsky Institute of Ukrainian Archeography and Source Studies of the NAS of Ukraine were involved in preparing popular-science edition “False Russia”: Imitation of Greatness and Might” (scholarly editor — Halyna Zelenko). The publication analyzed the actual state of affairs in Russia in terms of the nature of its political regime, narratives of Russian state ideology, existent and potential socio-political divides and disunities, ethno-national processes in the federation subjects, the nature of Russian “claims” against Ukraine.

On 2 May, 2024, the VI Panel Discussion ‘Current Russian-Ukrainian War as a conflict of values and ideologies’ was held at Kuras Institute of Political and Ethnic Studies of the NAS of Ukraine. The event was organized in cooperation with the National Academy of Security Service of Ukraine and a number of NAS institutions.

I. Krypyakevych Institute of Ukrainian Studies of the NAS of Ukraine published the book “Conceptualization of Memorial Discourse in the Context of Russian-Ukrainian War”, where scholars analyzed the processes of Ukrainians’ collective memory evolution since 2014, with the main accent made on the full-scale RF invasion

of Ukraine in February 2022, perpetuating the memory of the armed confrontation heroes and memorializing the war; revealing the opposition of the Russian and Ukrainian historical, cultural and communicational memory.

The issues of the ruinous action of the “Russian world” ideology and the need to counteract it in the realm of the activities of religious institutions in Ukraine were analyzed in the collective monograph of the scholars of H.S. Skovoroda Institute of Philosophy of the NAS of Ukraine “Religion and War: Contemporary Ukrainian Context”.

V.I. Vernadsky National Library of Ukraine is engaged in developing theoretical foundations for the comprehensive issues of the effective counteraction to enemy’s PSYOPS. The main study areas are: ‘Manipulative technologies in today’s environment and problems of their neutralization’, ‘Strategic communications in counteracting destructive Russian narratives’, ‘Scientific library resource-based studies of the issues of internally displaced people/refugees and labor market in the context of Russia’s full-scale military aggression’.

O.O. Potebnia Institute of Linguistics of the NAS of Ukraine, held the II Session of Potebnia Collegium — the linguistic online school designed to popularize recent achievements of linguistic research. In particular, in the framework of the event, lectures ‘Once again about the age of the Ukrainian language’ by NAS academician Hryhorii Pivtorak and ‘The Ukrainian written language of the XI—XIV centuries. Refuting Russian myths’ by NAS corresponding member Victor Moysiienko, who is now serving in the Armed Forces of Ukraine, were delivered. The reviewers deconstructed common misconceptions of the origins of the Ukrainian and Russian languages that had become strongly established in Russian science and mass culture and were picked up by aggressor’s state propaganda.

Scholars of O.O. Potebnia Institute of Linguistics also took part in preparing the exhibition ‘Lingvocide as a component of Rashism’, which was held in Kyiv and was organized in cooperation with the Ukrainian Institute of National Remembrance under the aegis of the State Language Protection Commissioner.

Rylsky Institute of Art Studies, Folklore and Ethnology of the NAS of Ukraine organized and held scientific-and-practical conference ‘Cultural heritage and identification processes of wartime hardships: theoretical and applied aspects of research’, which became for scholars in humanities the site for discussing the key issues of preserving and studying the cultural legacy, strengthening state-identification and nation-consolidation processes.

# SCIENCE POPULARIZATION. PUBLIC RELATIONS

The search for new forms of establishing effective interaction between scientists and media representatives and the public is ongoing. NAS scientists regularly participate in TV and radio programs, publish articles on the pages of leading printed and online editions, are active contributors in social networks on scholarly topics, act as organizers and participants of popular-science activities aimed at different age groups of people. In particular, popular-science lectures and seminars, specialized exhibitions of innovative developments, scientific picnics, book presentations, sightseeing tours to research institutions are among the forms of maintaining and deepening ties between the academic community and the general public.

Regular work on filling the official website of the National Academy of Sciences of Ukraine and its Facebook page with news and information materials about Academy's life and achievements continues. In 2024, an updated version of the official web portal of the NAS of Ukraine was launched. Besides, informing the general public is carried out through the Internet sites of Academy institutions and their social media pages.

In spite of wartime realities and challenges, Academy institutions and scientists conducted constant education work and made significant efforts to popularize science and its achievements. In May, a number of events were organized for the Science Day in Ukraine, for example, on the occasion of the Science Day and the VII International Plant Day, *Fest Science & Plants* festival took place. M.M. Gryshko National Botanical Garden and the NAS Council of Young Scientists organized it with the support of the NAS President. Many Kyiv residents and guests of the capital visited the event.

Throughout the year, M.M. Gryshko National Botanical Garden invited visitors to interesting exhibition events: 'Spring Vernissage', 'Lilac Vernissage', 'Permaculture Festival', 'Autumn Festival', etc.

The National Museum of Natural History continued to entertain its visitors with various popular-science activities, among which were lectures, excursions, demonstrations, master classes, quests, which help to get to know the world of science and nature better.

The Main Astronomical Observatory (MAO) also held traditional popular-science events: 'Telescope Day' and 'Astro Autumn in Holosiiv', which provided for excursions to the Museum of MAO history, lectures, amateur

astronomical observations. In August 2024, the MAO Council of Young Scientists organized a summer school in astronomy and astrophysics 'Through the Milky Way into the Universe' for students of higher education institutions. Its participants had the opportunity to listen to review lectures on the achievements of scientists in various areas of astronomy, to apply the received theoretical knowledge at practical sessions, get practice in leading scientific discussions, make new acquaintances. Last June, young Academy scientists, in cooperation with a charitable organization, held excursions for children of military personnel and internally displaced people at E.O. Paton Electric Welding Institute and the Main Astronomical Observatory. Materials science scholars acquainted young researchers with cutting-edge developments and technologies in their field, showed them scientific laboratories. Astronomers presented them interesting facts about current astronomical studies, helped those who wanted to observe the Sun through a telescope.

Scientists of the State R&D Complex 'Institute for Single Crystals', under the motto "Science is cool!" continued to conduct excursions for schoolchildren, students and all those who are interested in science. That was an opportunity to learn about the specifics of scientists' work, get a lot of useful information on physics, chemistry, biomedicine, and nanotechnologies; expand knowledge about the possibilities of natural sciences and imagine themselves as future scientists.

Last June, specialists of the Institute of Plant Physiology and Genetics organized 'Field Day' events during which they introduced visitors to Institute's innovative scientific developments, exchanged their work experience and ideas on overcoming management problems under martial law.

Student science picnics *Academ Open Air*, organized by Kyiv Academic University and G.V. Kurdyumov Institute for Metal Physics, is a good spring tradition. That was the third time that these activities brought together young people of different natural and mathemati-



During 'Fest Science & Plants' festival organized by M.M. Gryshko National Botanical Garden and the NAS Council of Young Scientists



During a visit to the Main Astronomical Observatory of the NAS of Ukraine

cal specializations, IT, engineering and interdisciplinary fields. Its participants had an opportunity to listen to lectures of NAS scientists and invited speakers, communicate with scientists, take part in interesting contests and scientific experiments.

Scientists of the NAS of Ukraine continued their work within the framework of *Science Kids* popular-science lecture cycle for children on the *INSCIENCE* online platform, popularized science under 'Real Science' project. The popular-science program 'Conversations about the Universe with Ivan Kriachko' continued to appear on the YouTube channel *All about the Universe*.

The seminars launched by Academy scientists — in particular, 'Kharkiv chemistry seminar' (STC Institute for Single Crystals), 'Kharkiv quantum seminar' (B. Verkin Institute for Low Temperature Physics and Engineering and National Science Center Kharkiv Institute of Physics and Technology), interdisciplinary all-Academy natural-science seminar 'Current issues of physico-chemical and mathematical biology' (Palladin Institute of Biochemistry) — were working actively. Their aim is to unite Ukrainian and foreign scientists, motivate and educate a young generation of researchers.

Throughout the year, the program 'Competently about Science' continued to run on the NAS *YouTube* channel. Leading scientists and specialists in different areas were its guests. They spoke about the achievements and challenges of today's Ukrainian science. Last year, 33 interviews were presented.

In 2024, NAS scholars actively collaborated with Ukrainian media: TV channels, radio stations, printed and online periodicals, information agencies. For example, Academy President academician Anatolii Zago-



NAS Prize 'For Science Popularization' is handed to Vladyslav Khri-soforov, editor of 'Security Talks' project, for his program on 'Apostrophe TV' channel

rodniï talked in his interview to the journalists of the *Ukrinform*, *Svit* newspaper, *Herald of the NAS of Ukraine* journal about Academy's work in wartime, the main areas of applied and basic research that are developed today and are of great importance for the society and the state, about the cooperation with international partners, the problems which NAS scientists are faced with. With the participation of leading NAS scientists, a series of *Security Talks* TV programs were issued. They were concerned with science accomplishments and problems during the war, scientists' contribution to strengthening national security and defense, the post-war recovery of the state.

Over the year, the sites of the NAS of Ukraine and the Institute of Sociology published popular-science materials, which were authored by leading sociology scholars of the Academy, on the most relevant issues in the life of the Ukrainian society in wartime conditions.

The problems and achievements of the international and Ukrainian science, discussions about global challenges in the XXI century were presented to the readers of the *Svitohliad* popular-science magazine, which is published six times annually by the National Academy of Sciences of Ukraine jointly with the Main Astronomical Observatory.

The second honorary ceremony of presenting the NAS Prize 'For Science Popularization' (according to the 2023 results) took place at the regular session of the General Meeting of the NAS of Ukraine on 24 April 2024. Prize winners were selected in three categories. Since establishing the award its laureates had been chosen in 2022 and 2023, and the competition for the 2024 NAS Prize 'For Science Popularization' was announced.

# RECOGNITION OF THE ACHIEVEMENTS OF NAS SCIENTISTS

**V.I. Vernadsky Gold Medal** of the NAS of Ukraine was awarded to NAS academician Serhiy Komisarenko for outstanding achievements in molecular immunology and to NAS foreign member professor A. Ciechanover (Izrael) for prominent accomplishments in protein biochemistry.

**B.E. Paton Gold Medal** was awarded to A. Shcherba, department head at the Institute of Electrodynamics for developing the technologies of manufacturing high-voltage cable-and-wire products with cross-linked polyethylene insulation, implementing methods of their testing and diagnostics, and to V. Zolotaryov, director-general of 'PIVDENKABEL PLANT' Ltd. for organizing the serial manufacturing of such world-class products.

26 scholars of NAS institutions — E.O Paton Electric Welding Institute, Institute of Gas, G.V. Kurdyumov Institute for Metal Physics, I.M. Frantsevich Institute for Problems of Materials Science, Glushkov Institute of Cybernetics, D.K. Zabolotny Institute of Microbiology and Virology, I. Krypyakevych Institute of Ukrainian Studies, O.Ya. Usikov Institute for Radio Physics and Electronics — became winners of Borys Paton National Prize of Ukraine for their works "Creation of a model range of specialized armored vehicles", "Metal, metal-ceramic and ceramic materials and products thereof for armaments, military equipment and energy", "Innovative foundations of soils rehabilitation and irrigation in war and peace", "Complexes for organic waste recycling as an element of distributed generation in wartime", "United Ukraine in its struggle for state independence in 1917—1923", "Determining physical characteristics of electrodynamical structures for various purposes with microwave spectroscopy techniques".

25 associates of NAS institutions, organizations and enterprises were bestowed with state awards. Honored for significant achievements in strengthening Ukrainian statehood, courage and selflessness in defending Ukraine's sovereignty and territorial integrity, personal contribution to the development of various spheres of social life, conscientious performance of professional duty were:

Z. Nazarchuk, NAS academician, director of Karpenko Physico-Mechanical Institute — with the Order of Prince Yaroslav the Wise 5<sup>th</sup> Class;

R. Kushnir, NAS academician, director of Pidstryhach Institute for Applied Problems of Mechanics and Mathematics — with the Order of Merit 2<sup>nd</sup> Class;

I. Krivtsun, NAS academician, director of E.O. Paton Electric Welding Institute — with the Order of Merit 3<sup>rd</sup> Class;

S. Nosatyuk, senior research associate of O.Ya. Usikov Institute for Radio Physics and Electronics — with the Medal 'For Labor and Victory'.

A. Kramarenko, employee of STC Institute for Single Crystals, was awarded with the Order of Merit 3<sup>rd</sup> Class for personal courage in defending the state sovereignty and territorial integrity of Ukraine and selfless performance of military duty.

Z. Maizelis, senior research associate of O.Ya. Usikov Institute for Radio Physics and Electronics, was honored with the Order of Merit 3<sup>rd</sup> Class for a major personal contribution to advancing national education, training of highly qualified specialists, courage and selflessness in defending the sovereignty and territorial integrity of Ukraine, many-year fruitful pedagogical work and high professionalism.

Awarded with the Order of Merit 3<sup>rd</sup> Class for significant personal contribution to the progress of Ukrainian science, enhancing nation's S&T potential under martial law, dedicated work of many years and high professionalism were:

Yu. Izotov, NAS academician, chief research associate of Bogolyubov Institute for Theoretical Physics, — with the Order of Merit 3<sup>rd</sup> Class;

with the Medal 'For Labor and Victory' — P. Artymyshyn, senior research associate of I. Krypyakevych Institute of Ukrainian Studies; O. Volkov, director of the International Scientific and Training Center of Information Technologies and Systems; A. Goncharenko, junior research associate of O.O. Potebnia Institute of Linguistics; R. Djabrailov, deputy director of V.K. Mamutov In-



*NAS academician Anatolii Zagorodnii, President of the NAS of Ukraine, presents V.I. Vernadsky Gold Medal to NAS academician Serhiy Komisarenko*



*Volodymyr Zelensky, Ukraine's President, during a meeting with young scientists presents Medal "For Labor and Victory" to Oleksandr Dubikovsky, senior research associate of V.Ye. Lashkaryov Institute of Semiconductor Physics of the NAS of Ukraine*

stitute of Economic and Legal Research; O. Dubikovsky, senior research associate of V.E. Lashkaryov Institute of Semiconductor Physics; A. Zolotarenko, acting laboratory head of I.M. Frantsevich Institute for Materials Science; O. Zolotarenko, senior research associate of Chuyko Institute of Surface Chemistry; V. Kovach, leading research associate of the Center for Information, Analytical and Engineering Support to Monitoring of Nuclear Power Facilities; O. Mayevskyi, senior research associate of the Institute of the History of Ukraine; O. Popov, acting director of the Center for Information, Analytical and Engineering Support to Monitoring of Nuclear Power Facilities; O. Tolstov, department head at the Institute of Macromolecular Chemistry; V. Chernyshenko, deputy director of Palladin Institute of Biochemistry.

The title 'Honorary Worker of Science and Technology of Ukraine' was conferred to: N. Kosey N. Zherdiova, department heads of the Centrum of Innovative Medical Technologies; V. Guylianskyi, NAS correspondent member, adviser to the directorate of the Institute of Applied Mathematics and Mechanics; A. Nosovskyi, NAS academician, director of the Institute for Safety Problems of Nuclear Power Plants; D. Rakhmetov, deputy director of M.M. Gryshko National Botanical Garden; O. Tolmachov, Dr. of Physics and Mathematics, deputy director of the Institute for Single Crystals.

For significant personal contribution to organizing and providing comprehensive aid to the personnel of military units of the Armed Forces of Ukraine, fruitful collaboration with the Armed forces, supporting the fighting spirit of defenders of Ukraine's state sovereignty and territorial integrity, active volunteer work, the Ministry of Defense of Ukraine honored scientists of the Institute of General Energy: I. Didenko, deputy

director for general issues, — with the Medal 'For Promoting the Defense of Ukraine'; A. Zaporozhets, deputy director for scientific research administration, S. Kovtun, deputy director for research work, and O. Illiasov, leading legal adviser, — with the Medal 'For Assistance to the Armed Forces of Ukraine'.

For special merits in strengthening the defense capability of the state, high personal accomplishments in implementing the results of defense research during development and upgrading armament and military equipment specimens, high professionalism shown under martial law, awarded with the Medal 'For Promoting the Defense of Ukraine' were: H. Bahliuk, NAS corresponding member, acting director of I.M. Frantsevich Institute for Problems of Materials Science; V. Kremenytsky, department head at the NAS Technical Center; V. Poznyakov, NAS academician, deputy director for R&D work of E.O. Paton Electric Welding Institute; I. Prytula, NAS academician, director of the Institute for Single Crystals; S. Sperekach, director of NAS Technical Center; O. Shinskyi, department head at the NAS Physico-Technological Institute of Metals and Alloys.

For significant personal contribution to building up, developing and providing support to the Armed Forces of Ukraine, dedicated service to the Ukrainian people, excellent performance of official duty, high professionalism shown under conditions of the Russian Federation's aggression against Ukraine, I. Kvashenko, director of the R&D Center for Metal Treatment with Explosion at E.O. Paton Electric Welding Institute, was awarded with the Medal 'For Assistance to the Armed Forces of Ukraine'.

The title 'Honorary Doctor of the National Academy of Sciences of Ukraine' was conferred on three foreign scientists: professor Helmut Dosch, Chairman of the Board of Directors of *Deutsches Elektronen Synchrotron*, Hartmut Abel, American historian and author, professor of Yale University, and Gerald Haug, President of *Leopoldina* National Academy of Sciences of Germany.

A number of awards were won by young researchers of the Academy. The Prize of the President of Ukraine for young scientists was presented to 16 scholars. The Prize of the Verkhovna Rada of Ukraine was awarded to 41 young researchers, and the scholarship of the Verkhovna Rada of Ukraine was awarded to four young doctors of science.

The Prize of Kyiv Mayor went to five young researchers.

Mark Azbel International Prize, which is intended for supporting young scientists in theoretical physics and was founded in the spring of 2024 in honor of Mark Azbel — a prominent physicist, dissident, the organizer of scientists' resistance to soviet totalitarian regime, professor of Tel-Aviv University, who started his scientific career at Kharkiv University — was awarded to Z.

Maizelis, leading research associate of O.Ya. Usikov Institute for Radio Physics and Electronics.

Four Academy employees and one R&D team were awarded with Diploma of the Verkhovna Rada of Ukraine and Honorary Diploma of Verkhovna Rada of Ukraine, 17 NAS employees got the acknowledgement of Kyiv mayor, three researchers were awarded with Honorary Diplomas.

Achievements of Academy scientists were honored with numerous awards of leading Ukrainian, international and foreign organizations.

V. Ya. Tatsiy Gold Medal of the Academy of Legal Sciences of Ukraine was awarded to NAS academician V. Semynozhenko, head of the North-East Science Center of the NAS and the MES of Ukraine, for his prominent personal contribution to the advancement of state-of-the-art technologies and innovative developments, upgrading scientific and educational spheres, increasing the role of basic science, long-term public and political activities, many years of dedicated and fruitful work.

G. Redkina, junior research associate of STC 'Nuclear Fuel Cycle' of the NAS of Ukraine became the winner of the project contest in nuclear science, atomic energy and industry 'Atom innovators — 2024', which was held by Ukrainian Nuclear Society with the support from 'Energoatom' NAEC, *Energy Safety Group*, *Fenix Contact Ukraine* company et al., in the 'Scientific research' nomination.

Two female scientists of the Academy — O. Pariyska, research associate of L.V. Pisarzhevsky Institute of Physical Chemistry, and Yu. Shlapa, senior research associate of V.I. Vernadsky Institute of General and Inorganic Chemistry — became the laureates of the V Ukrainian L'ORÉAL-UNESCO Prize "For Women in Science", initiated by L'ORÉAL company in 1998 for encouraging young women to choose profession in the area of natural sciences.

54 Academy scientists became the winners of NAS prizes named after prominent scholars, received various departmental awards for personal research achievements and pro-active public work.



*NAS academician Anatolii Zagorodnii presents S. Subbotin Prize for prominent achievements in geophysics, hydrophysics, scientific instrument making, meteorology and atmospheric physics to Olga Legostayeva, deputy director of S. Subbotin Institute of Geophysics*

Nine people won the NAS prize 'For Popularizing Science'. The Academy founded this award to mark media and their individual representatives, scientists, and organizers of independent projects for the best material about scientists' accomplishments, the activities of research institutions and the Academy as a whole, as well as for promoting the popularization of science and raising the prestige of the scientific profession in Ukraine.

Throughout 2024, 801 people received NAS honors: 27 people — 'For scientific achievements', 57 — 'For training young scholars', 115 — 'For professional accomplishments', 20 people — 'For promoting science advancement', and 38 young scientists got the honorary distinction 'Talent, inspiration, work'.

On the occasion of memorable dates, for fruitful work, significant contribution to the development of science 300 people and 6 work teams were awarded with NAS acknowledgements, 154 people and two work teams received honorary diplomas of the NAS Presidium and the Central Committee of the NAS Trade Union, and five people got the Honorary Diploma of the NAS Presidium.

# REFERENCE INFORMATION. STATISTICS

## Structure of the NAS of Ukraine

The structure of the NAS of Ukraine includes 3 sections and 14 departments, which incorporate 149 research institutions. Research-and-production organizations (design offices, pilot production facilities etc.) operate within some scientific institutions. Functioning within some research institutions are science objects that have the status of National Asset (nuclear, physical and astronomical research facilities, test bench complexes, archive scientific collections and museum displays, plant genetic funds, collections of microorganism strains and plant lines, cell banks, landmarks of history and culture etc.), as well as centers for shared use of scientific equipment.

### Research organizations that have the status of National Institution:

- V.I. Vernadsky National Library of Ukraine
- V. Stefanyk National Scientific Library of Lviv
- National Science Center "Kharkiv Institute of Physics and Technology"
- "Olbia" National Historical and Archeological Reserve
- M.M. Gryshko National Botanical Garden
- "Sofiivka" National Dendrological Park
- National Museum of Natural History
- National Center "Junior Academy of Sciences" of the MES of Ukraine and the NAS of Ukraine.

Functioning in the Academy are **five Regional Science Centers** of dual subordination to the NAS of Ukraine and the Ministry of Education and Science of Ukraine:

- Donetsk Science Center (Kramatorsk, Donetsk oblast)
- Western Science Center (Lviv)
- Southern Science Center (Odesa)
- North-East Science Center (Kharkiv)
- Prydniprovskiyi Science Center (Dnipro),

The statutory activities of Crimean Science Center and its funding from the NAS budget were suspended in 2014.

## Distribution of institutions across sections and departments

Department	The number of scientific institutions	The number of R&D organizations	Objects with the National Asset status	Centers for shared use of research equipment
<b>Section of Physical, Engineering and Mathematical Sciences</b>				
Mathematics	3	—	—	—
Informatics	9	—	—	1
Mechanics and Mechanical Engineering	7	3	3	4
Physics and Astronomy	13	2	10	17
Earth Sciences	14	1	1	5
Materials sciences	12	17	2	12
Energy	10	2	2	4
Nuclear Physics & Energy	6	2	2	5
<b>Section of Chemical and Biological Sciences</b>				
Chemistry	13	11	—	13
Biochemistry, Physiology & Molecular Biology	9	1	5	9
General Biology	20	1	17	13
<b>Section of Social Sciences and Humanities</b>				
Economics	8	—	—	—
History, Philosophy & Law	17	3	5	—
Literature, Language & Art Studies	8	—	4	—

## Regional structure of the NAS of Ukraine

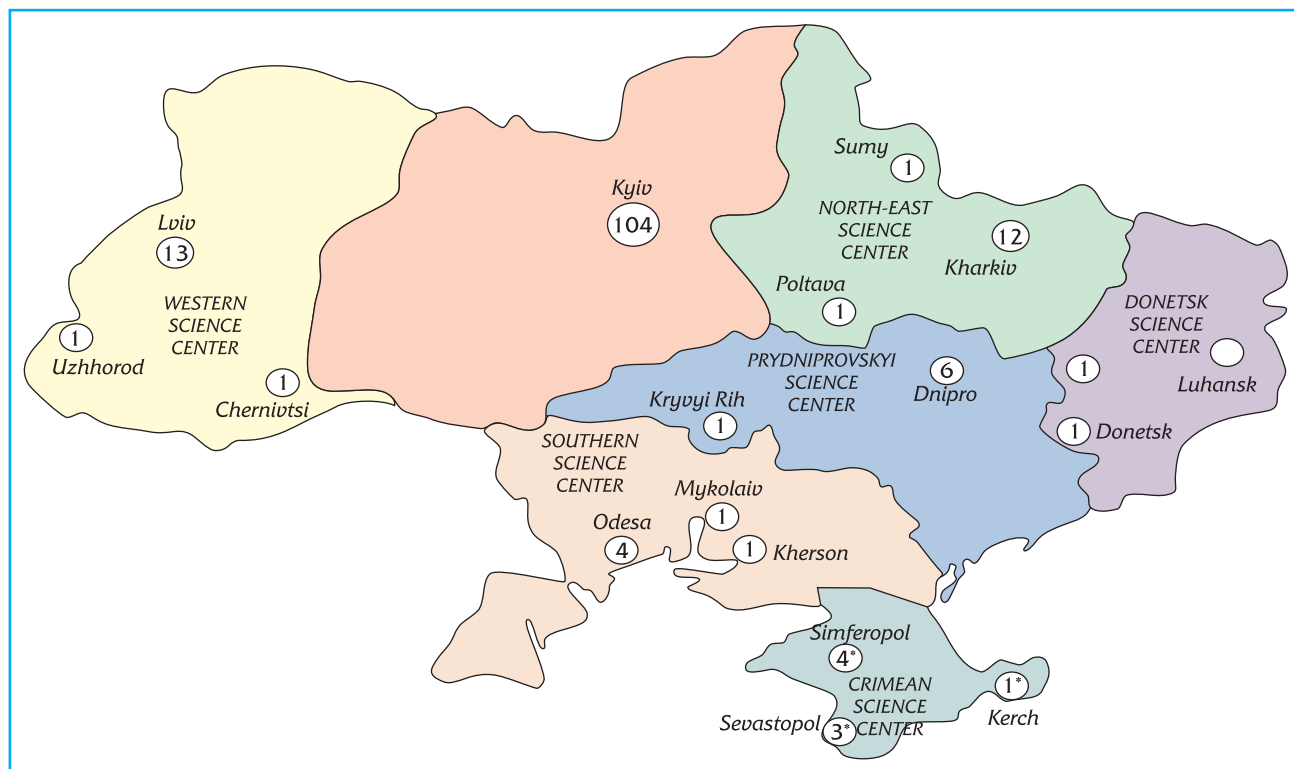

Figures in the map show the number of research institutions

\* The status of NAS institutions located in the Autonomous Republic of Crimea is defined by the Law of Ukraine of 15.04.2014 № 1207-VII 'On guaranteeing the rights and freedoms of citizens and legal regime on the temporarily occupied territories of Ukraine'

## Conducting scientific research

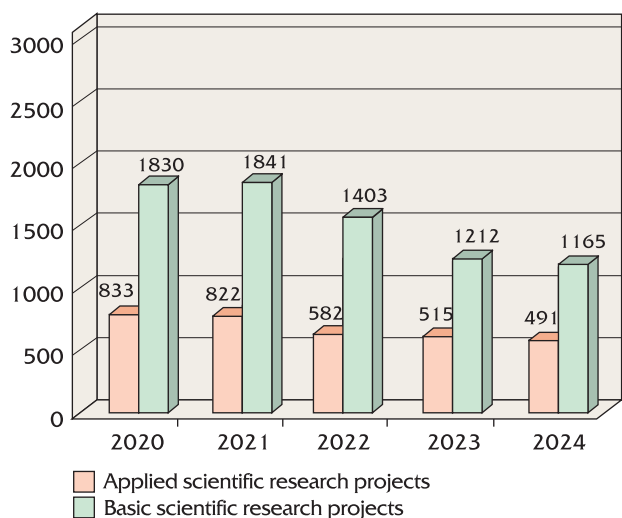

The number of currently implemented research projects financed from the general fund of the State Budget

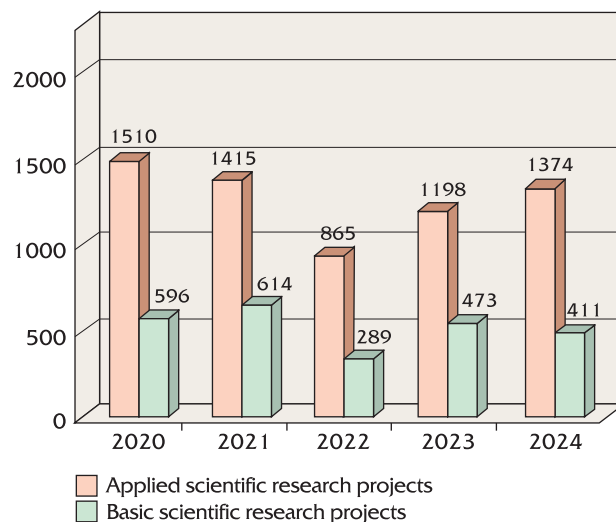

The number of currently implemented research projects financed from the special fund of the State Budget

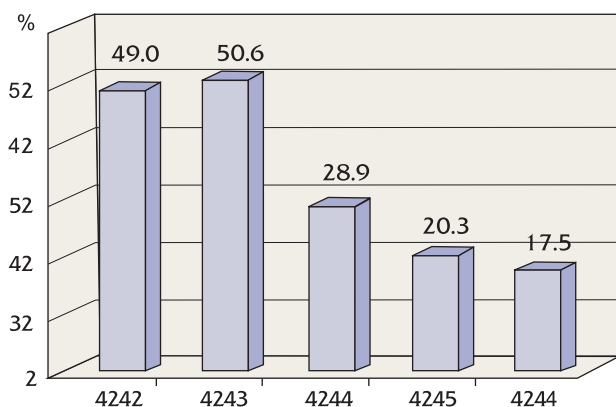

Part of targeted-program and contest-based projects of the NAS of Ukraine in the total number of R&D works

**Targeted-program and contest-based research projects of the NAS of Ukraine in 2024 involved the research conducted under:**

- 1 NAS targeted program of applied research;
- 3 targeted research projects; and those based on the results of:
  - contest of scientific and S&T projects implemented in the area ‘Support to scientific and S&T (experimental) developments that are of priority to the state’;
  - contests of research projects of young scientists of the NAS of Ukraine;
  - NAS grants to research laboratories/groups of young NAS scientists for conducting research in priority areas of science and technology.

**Publication activity**

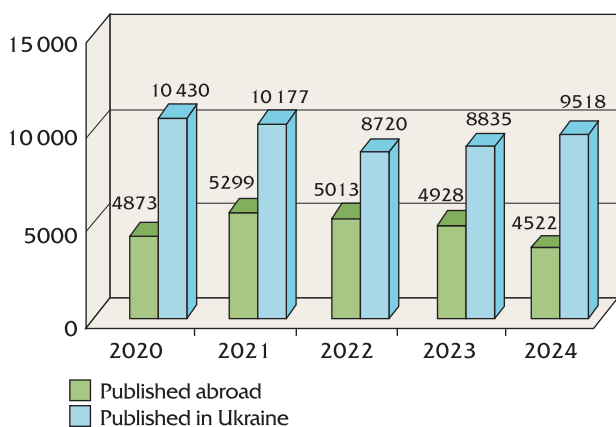

The number of papers by NAS scientists in periodicals

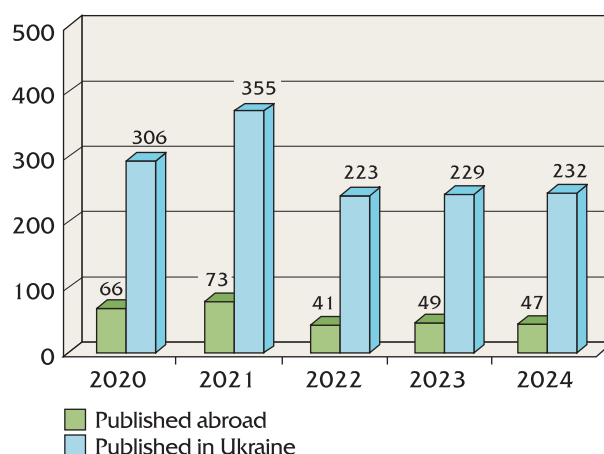

The number of monographs

**Publishing activities**

• **The total number of Academy journals:** 84 scientific journals, 1 popular-science journal (*Svitohliad*), and *Dzherelo* abstract journal in four series;

• **12 journals are published in English in Ukraine:**

1. Science and Innovation
2. Semiconductor Physics, Quantum Electronics & Optoelectronics
3. Journal of Mathematical Physics, Analysis, Geometry
4. The Paton Welding Journal
5. Progress in Physics of Metals
6. Journal of Thermoelectricity
7. Ukrainian Journal of Physics
8. Functional Materials
9. Biopolymers and Cell
10. Experimental Oncology
11. Problems of Cryobiology and Cryomedicine
12. Zoodiversity

**14 journals are published in English abroad:**

by Springer Publishers

1. Ukrainian Mathematical Journal
2. Cybernetics and Systems Analysis
3. International Applied Mechanics
4. Strength of Materials
5. Materials Science
6. Theoretical and Experimental Chemistry
7. Neurophysiology
8. Kinematics and Physics of Celestial Bodies
9. Journal of Superhard Materials
10. Journal of Water Chemistry and Technology
11. Cytology and Genetics

by Begell House Inc. Publishers

12. International Journal on Algae
13. Hydrobiological Journal

by other publishers

14. Low Temperature Physics (American Institute of Physics)

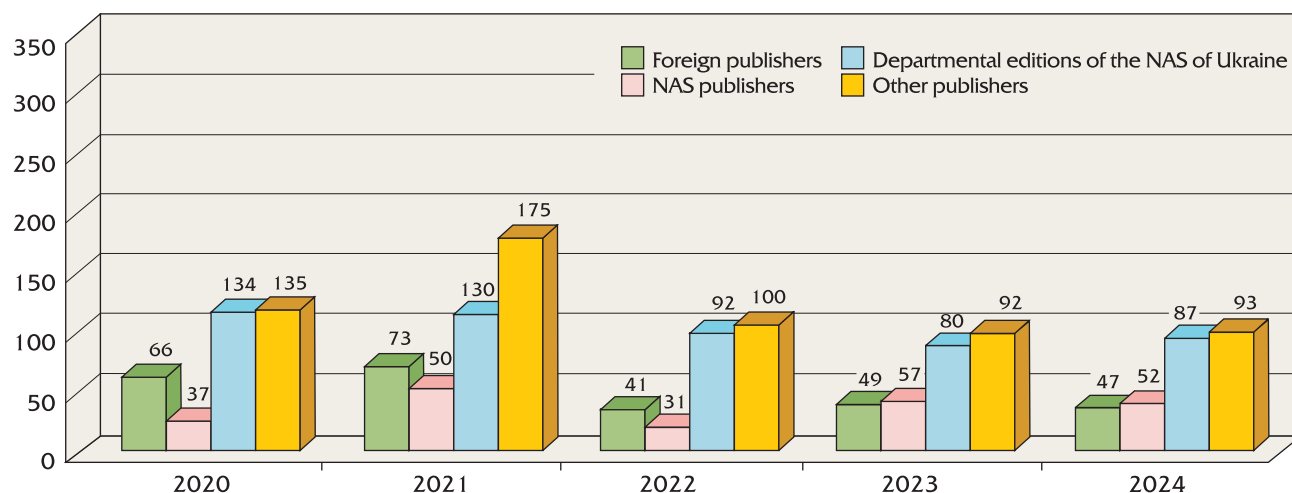

Distribution of scientific monographs across publisher groups

### Scientific expert activities

#### In 2024 NAS experts were involved in preparing:

- The plan of Government’s priority actions in 2024;
- The concept of State Targeted Economic Program of developing titanium industry of Ukraine till 2028;
- The strategy of developing agriculture and rural territories in Ukraine till 2030;
- The strategy of digital development of Ukraine’s innovative activities till 2030;
- The strategy of recovery, sustainable development and digital transformation of small and medium business till 2027;
- Concepts of implementing the state policy in promoting the development of socially responsible business in Ukraine till 2030;
- The strategies of developing Kyiv oblast for 2021—2027.

#### Expert conclusions, notes, proposals were prepared, in particular those concerning the legislation drafts:

- ‘On the industrial policy and predictability of the real sector of the economy’;
- On industrial policy and providing the continuity of business activities under martial law’;
- ‘On introducing amendments to some legislation acts concerning the improvement of industrial parks functioning’;
- “On social dialogue in Ukraine’;
- ‘On introducing amendments to some laws of Ukraine concerning the improvement of cybersecurity oversight procedures and establishment of European schemes of cybersecurity certification’;
- ‘On critical infrastructure’;
- ‘On introducing amendments to the Law of Ukraine ‘On humanitarian aid’.

Expert conclusions	2020	2021	2022	2023	2024
Expert conclusions concerning normative legal acts and program documents, information and analytical materials on various issues of socio-economic development provided for state power bodies	1850	1900	1800	1730	1820
Expert conclusions concerning the expediency of funding basic research projects from the State Budget	1081	440	412	279	254

### Innovation activities

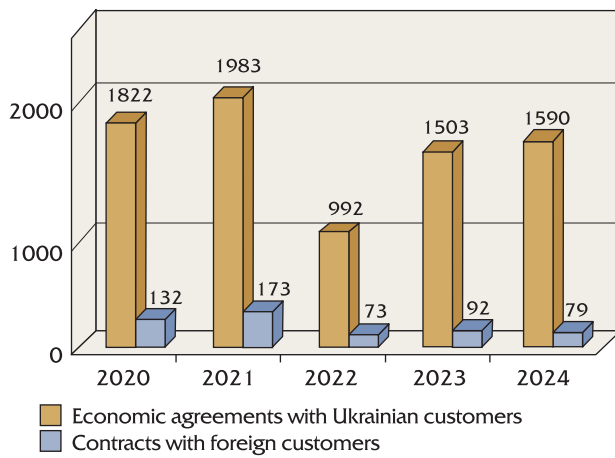

Economic agreements and contracts, the number

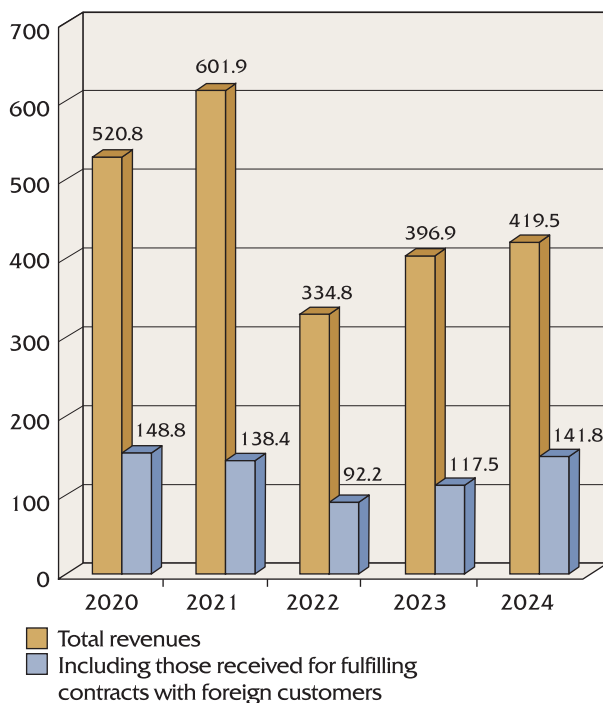

Revenues received by NAS institutions for fulfilling economic agreements and contracts, ₴ million

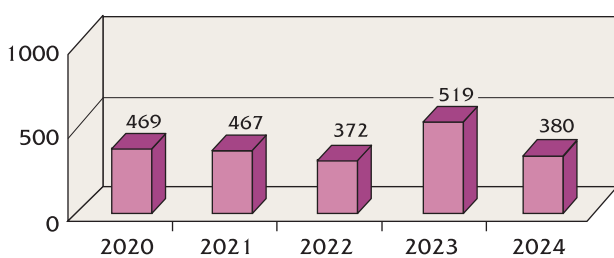

The number of deployed scientific products

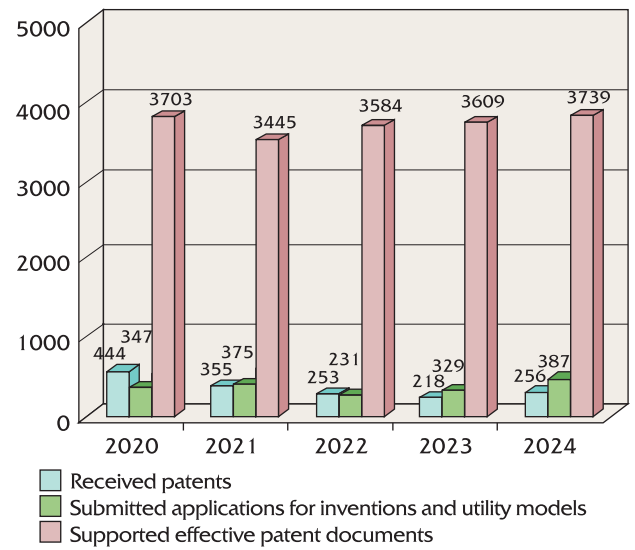

Creation of intellectual property objects, the number

### Collaboration with institutions of higher education and institutions of the MES of Ukraine

Collaboration agreements concluded between research institutions and institutions of higher education	270
Research topics and projects developed in collaboration with academics	163
Published monographs co-authored with academics	114
Research scientists who worked in education:	1299
including:	
NAS academicians	42
NAS corresponding members	90
Published textbooks and manuals for institutions of higher education	124
Scientists at the head of chairs in institutions of higher education	61
Students of higher education institutions who pursued/are pursuing Master's degree programs at joint research-and-training facilities hosted by scientific organizations:	
in academic year 2023/2024	499
in academic year 2024/2025	317
Students who prepared their graduation papers at research institutions	1075
Academics incorporated to specialized academic councils of research institutions	528
Scientists of research institutions incorporated to specialized academic councils of the institutions of higher education	400

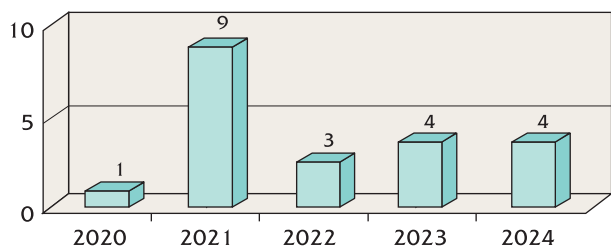

Joint research-and-training structures set up in the denoted year (without those set up earlier)

Newly employed fully graduate specialists at research institutions who attended study groups of the Junior Academy of Sciences in their school days	4
Research scientists and lecturers of the institutions of higher education and MES organizations who upgraded their professional skills at research institutions	405
Theses of academics defended at specialized academic councils of scientific research institution	30

### International ties

**Legal contractual framework for the international cooperation of the NAS of Ukraine** (effective agreements, contracts, memorandums etc.) – a total of 132 documents.

**In 2024, the National Academy of Sciences of Ukraine:**

- Became a member institution of Astroparticle Physics European Consortium (APPEC)
- Joined the Memorandum of understanding "For the Astroparticle Physics European Consortium" (APPEC) on 5 December 2024.

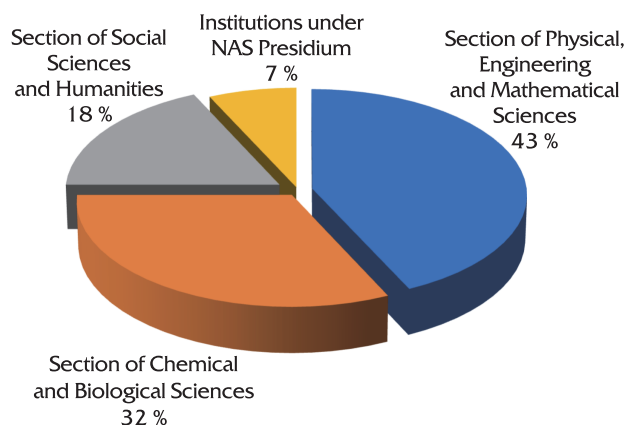

Distribution of direct agreements and contracts across the institutions of NAS sections

**Nearly 690 direct agreements and contracts** concluded by NAS institutions with international partners are in force. Of those, 299 were concluded by the institutions of the Section of Physical, Engineering and Mathematical Sciences, 220 — by institutions of the Section of Chemical and Biological Sciences, 123 — by those of the Section of Social Sciences and Humanities, 48 — by the institutions under NAS Presidium.

### Employment figures

(as of 01.01.2025)

The total number of employees	24 447
of them:	
at research institutions	23 533
at research-and-production facilities	729
at service organizations	185
The number of research scientists	13 241
of them:	
doctors of sciences	2322
candidates of sciences (PhDs)	6459
researchers without an advanced degree	4460
The number of young specialists recruited in 2024	302
The number of those who pursued post-graduate studies in 2024	1490
including those engaged in full-time studies	1378
Defended candidate-of-science or PhD theses	222
of those — candidate-of-science theses	23
Doctoral fellowships	171
Defended doctor-of-science thesis	37

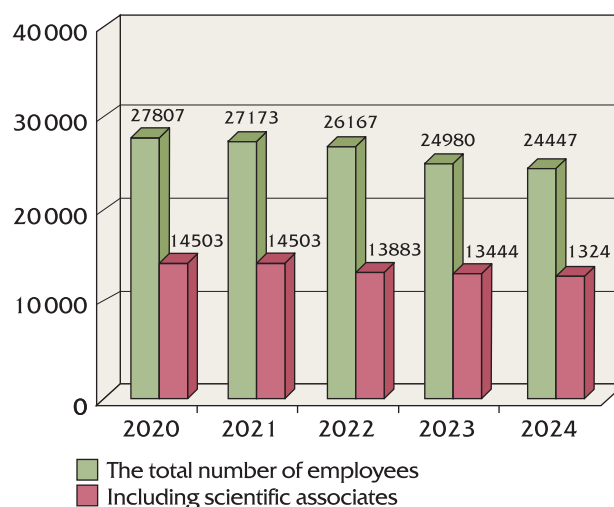

The number of employees

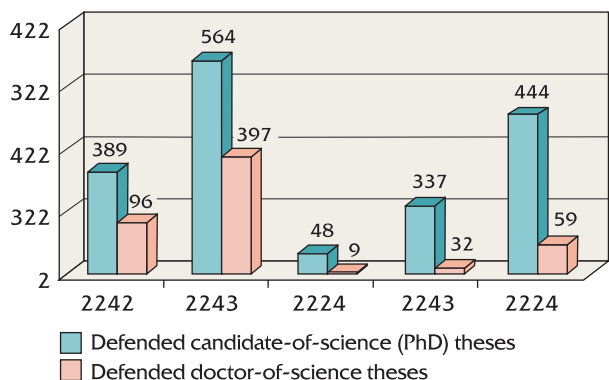

Training of scientific personnel, the number of people

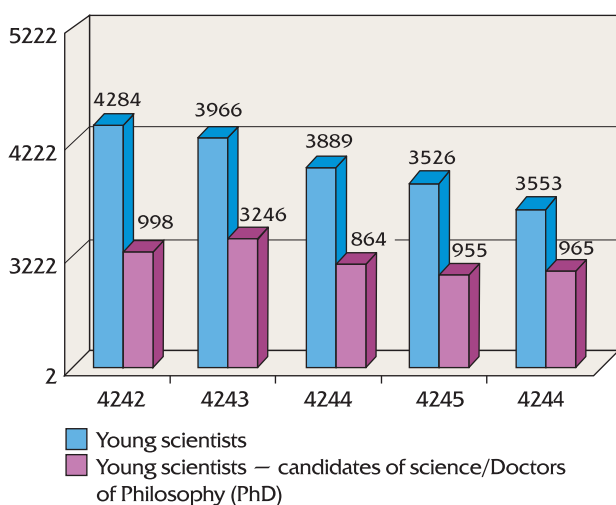

The number of young scientists

**Financial provision**

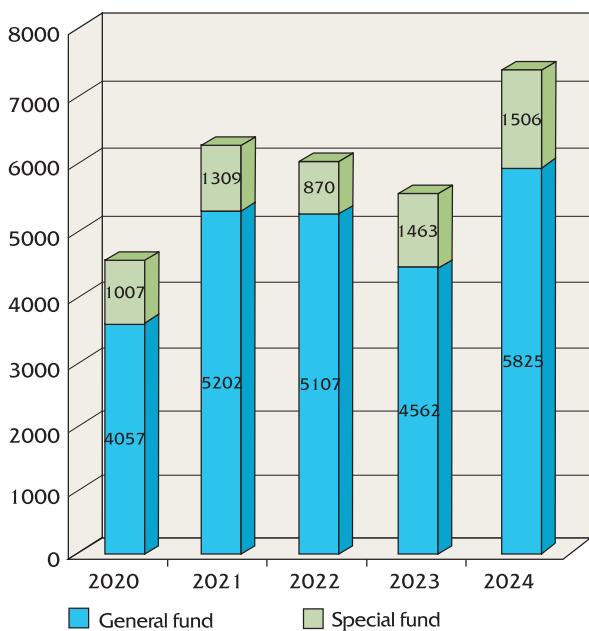

The total amount of NAS funding, ₴ million

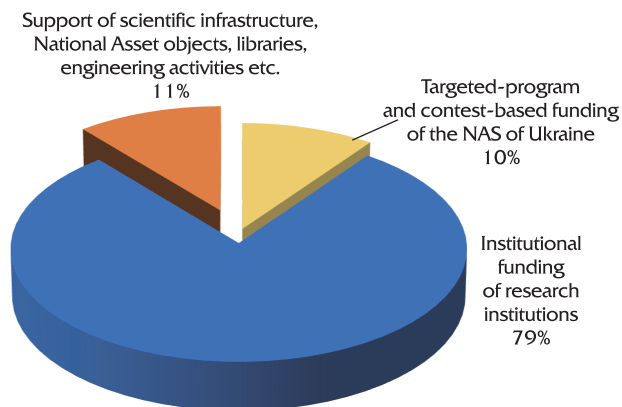

Distribution of general fund finance for conducting scientific research

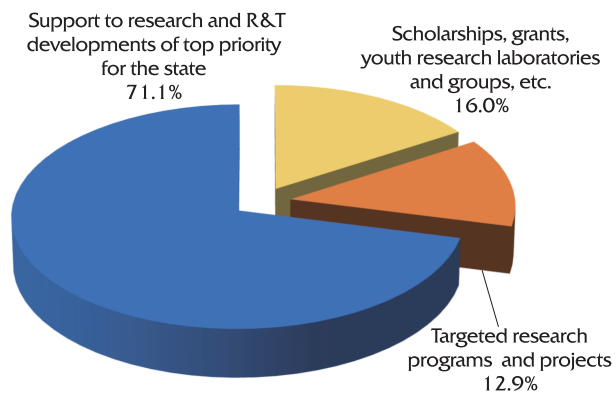

Targeted-program and contest-based funding

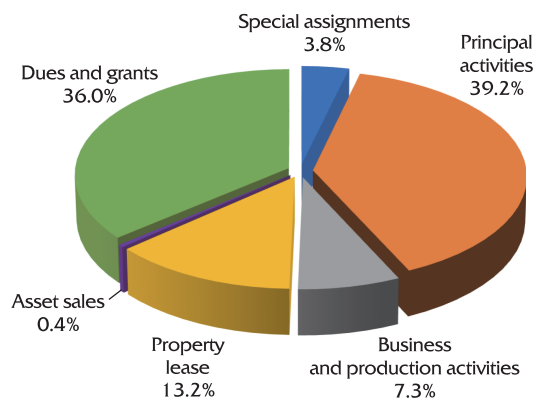

Structure of special-fund revenues